

Manual
Protection-System E16x446
with
Overspeed Protection
and
Voters for external Trip Release Conditions
IEC61508;SIL2 and API670 compliant

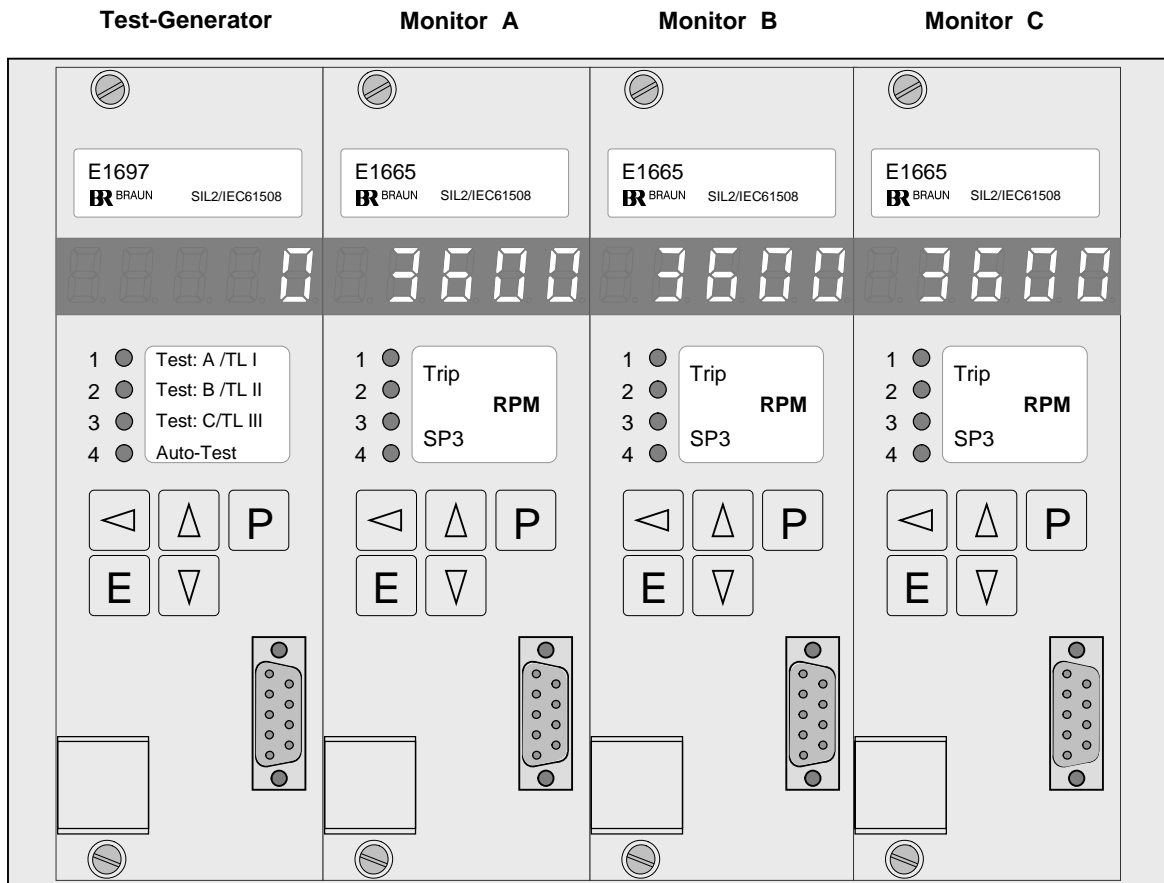

Figure 1: E16x446 System Front View

Contents	Page
1. General Informations	5
1.1. List of Figures.....	5
1.2. List of Abbreviations.....	6
1.3. System Applications and Definitions	8
1.3.1. System Applications.....	8
1.3.2. Definitions	8
1.4. Key Features of System E16x446.....	9
1.5. Ordering Key for Systems E16x446.abc.....	10
1.6. Compliance	11
1.6.1. Compliance with IEC61508; SIL2.....	11
1.6.2. Reserved	11
1.6.3. Reserved.....	12
1.7. Safety Data.....	13
1.7.1. Safety Data IEC61508; SIL2	13
1.7.2. Reserved.....	13
2. System Structure and I/Os.....	14
2.1. System Structure.....	14
2.1.1. Speed Sensors.....	14
2.1.2. System Components.....	14
2.1.3. System Design	14
2.1.4. System Structure Diagrams	15
2.1.5. System Wiring Diagrams.....	17
2.1.6. Connection of Sensors to the Speed Signal Inputs	19
2.2. Inputs of the System	20
2.2.1. Speed Signal Inputs	20
2.2.2. Direction Signal Inputs (F/R : Forward/Reverse).....	20
2.2.3. Input Reset of Alarms.....	20
2.2.4. Input Test Lock.....	20
2.2.5. Input Start Auto-Test-Sequence.....	21
2.2.6. Inputs Test I, Test II , Test III.....	21
2.2.7. Inputs Starter (Override of SP2).....	21
2.2.8. Inputs SP1B valid.....	21
2.2.9. Inputs Feedback from Solenoid Valve Block.....	21
2.2.10. Inputs for Voter 1.....	22
2.2.11. Inputs for Voters 2 ... 6	22
2.2.12. Inputs for Watchdog.....	22
2.3. Outputs of the System.....	23
2.3.1. Outputs System Warning Alarm 1 and System Warning Alarm 2.....	23
2.3.2. Speed Signal Repeater Outputs.....	23
2.3.3. Outputs Monitor Warning Alarm	23
2.3.4. Outputs Speed Alarm SP3	23
2.3.5. Analog Outputs for measured speed (Option).....	24
2.3.6. Outputs Direction Detection	24
2.3.7. Speed Trip Logic Output (2oo3 voted)	24
2.3.8. Outputs Trip-Lines IV, V, VI.....	24
2.3.9. Outputs Trip-Lines I, II, III.....	24
2.3.10. Logic Outputs LO1 through LO6 (voted 2oo3)	24
2.3.11. This chapter is left blank intentionally	24
2.3.12. Logic Output Watchdog (voted 2oo3)	25
2.4. Power Supply	25
2.5. Data-Interface	25
2.5.1. Profibus-Interface for Status and Diagnostics of the System	25
2.5.2. RS232-Interface for Setting of Parameters	25
3. Technical Specifications	26
3.1. Technical Data of Inputs	26
3.1.1. Technical Data of Speed Signal Inputs	26
3.1.1.1. Hall Sensor Inputs.....	26

3.1.1.2.	Eddy Current Sensor Inputs resp. MPU (Magnetic Pick-Up) Inputs.....	26
3.1.2.	Technical Data of Direction Inputs	26
3.1.3.	Technical Data of Binary Inputs (excluding Voter 1)	26
3.1.4.	Technical Data of Binary Inputs of Voter 1.....	26
3.2.	Technical Data of Outputs.....	27
3.2.1.	Technical Data of Sensor Signal Repeater Outputs.....	27
3.2.2.	Technical Data of Analog Outputs.....	27
3.2.3.	Technical Data of Opto-Relay Outputs.....	27
3.2.4.	Technical Data of Logic Outputs	27
3.2.5.	Technical Data of Trip-Lines IV, V, VI	27
3.2.6.	Technical Data of Trip-Lines I, II, III	27
3.3.	Technical Data of Power Supply	28
3.4.	Installation Conditions	28
3.5.	Protection Grade	28
3.6.	Connectors.....	28
3.7.	Conformity to Standards.....	28
3.8.	Dimensions of System E16A446.....	29
3.9.	Dimensions of System E16E446.....	30
3.10.	Dimensions and Features of E16G446 Enclosure	31
3.11.	Weight of E16x446.....	31
3.12.	Material specifications of E16A446 or E16E446	31
4.	Safety Notes for Installation and Operation.....	32
4.1.	Safety Notes for Installation	32
4.1.1.	General Instructions	32
4.1.2.	EMI.....	32
4.2.	Safety Notes for Operation.....	32
4.2.1.	Safety notes for commissioning	32
5.	Description of Monitor E1665.....	33
5.1.	Display and Frontside Operational Elements	33
5.1.1.	Front View of Monitor E1665.....	33
5.1.2.	Status-LEDs	33
5.1.3.	Display during Test Procedures	33
5.1.4.	Values accessible during normal operation	34
5.1.5.	Display of Firmware release state and CRC-Parameter-Checksum of Monitor	34
5.1.6.	Special Display Mode 1	34
5.1.7.	Special Display Mode 2.....	34
5.1.8.	Frontside Reset of Alarms and Event Codes	34
5.1.9.	Data Interface.....	34
5.2.	Functions of Monitor E1665	35
5.2.1.	Speed Measurement.....	35
5.2.2.	Functions for Overspeed Protection.....	35
5.2.3.	Functions for External Trip by Voters	35
5.2.4.	Selftest of Monitor	35
6.	Description of Test-Generator E1697	36
6.1.	Display and Frontside Operational Elements	36
6.1.1.	Front View of Test-Generator E1697	36
6.1.2.	Status-LEDs	36
6.1.3.	Display during Test Procedures	37
6.1.4.	Values accessible during normal operation	37
6.1.5.	Display of Firmware release state and CRC-Parameter-Checksum of Test-Generator.....	37
6.1.6.	Frontside Reset of Alarms and Event Codes	37
6.1.7.	Manual Start of a Monitor-Test Sequence.....	37
6.1.8.	Manual Start of a Trip-Line-Test Sequence	37
6.1.9.	Data Interface.....	37
6.2.	Functions of Test-Generator 1697	38
6.2.1.	Test of Feedback Signals.....	38
6.2.2.	Monitor-Test Sequence	38
6.2.3.	Trip-Line-Test Sequence (Test of 2003 solenoid valve block)	39
6.2.4.	Cross-check between CPUs of Test-Generator	39
6.2.5.	Selftest of CPUs	39

7.	Programming of the Modules.....	40
7.1.	Programming of the Modules via Front Keyboard.....	40
7.2.	Reserved.....	41
7.3.	Programming of the Modules via RS232-Interface	41
7.4.	Default Values.....	41
7.5.	Behaviour in case of values exceeding limits.....	41
7.6.	Display of parameter values if access is locked.....	41
8.	Parameters of Monitor E1665.....	42
8.1.	Summary of parameters and their default values.....	42
8.2.	Description of Parameters and their Settings of Monitor E1665	46
9.	Parameters of Test-Generator E1697	74
9.1.	Summary of parameters and their default values.....	74
9.2.	Description of Parameters and their Settings of Test-Generator E1697	75
10.	Event Codes and Troubleshooting.....	81
10.1.	Event Codes on display of E1665	81
10.2.	Troubleshooting if display of Monitor reads E.0.4.x.x.....	82
10.3.	Event codes on display of E1697	83
11.	Revision notes.....	85

1. General Informations

1.1. List of Figures

Figure 1:	E16x446 System Front View	1
Figure 2:	E16x446 System Structure Diagram 1 of 2	15
Figure 3:	E16x446 System Structure Diagram 2 of 2	16
Figure 4:	E16x446 System Wiring Diagram 1 of 3	17
Figure 5:	E16x446 System Wiring Diagram 2 of 3	18
Figure 6:	E16x446 System Wiring Diagram 3 of 3	19
Figure 7:	Dimensions of System E16A446	29
Figure 8:	Dimensions of System E16E446	30
Figure 9:	Dimensions of E16G446 Enclosure	31
Figure 10:	Front view of Monitor E1665	33
Figure 11:	Front view of Test-Generator E1697	36
Figure 12:	SP1 as a variable of the acceleration	54

1.2. List of Abbreviations

Abbreviation	Meaning
altern.	alternative
API	Technical standards of the "American Petroleum Institute"
A5S	BRAUN GmbH Sensor series
AWG/kcmil	Code number according to the "American Wire Gauge" System
approx.	approximately
CCF	Common Cause Failure
CPU	Central Processing Unit
DCavg	Diagnostic Coverage average
DIN	Deutsches Institut für Normung (German Institute for Standardization)
dN/dt	Change of speed per time unit (Acceleration)
EEPROM	Electrically Erasable Programmable Read-Only Memory
EMV	Electro magnetic compatibility
EN	European Norm
F/R	Forward/Reverse (Forward/Backward)
HE	Height units
HFT	Hardware Failure Tolerance
IEC	International Electrotechnical Commission
incl.	inclusive
IPxx	Ingress Protection Number xx according to DIN EN 60529
ISO	International Organization for Standardization
LED	Light Emitting Diode
LOx	Logic Output x
max.	maximum
min.	minimum
MPU	Magnetic Pick Up
MTTFd	Mean Time To Failure dangerous
n	Short term for Speed
NEMAx	National Electrical Manufacturers Association Number x
PFDavg	Probability of Failure on Demand average
PELV	Protective Extra Low Voltage
RAM	Random Access Memory
RPM	Revolutions Per Minute
sec	second
SELV	Safety Extra Low Voltage
SFF	Safe Failure Fraction
SILx	Safety Integrity Level x
SPx	SetPoint x
SPVx	SetPoint Voter x
SP1var	SetPoint 1 variable
TE	Width unit
TMR	Triple Modular Redundant
Tproof	Proof Test Interval
UL/cUL	Acc. US Underwriter Laboratories resp. Canadian Underwriter Laboratories standards
Vdc	Volt direct current
Vpp	Volt peak-to-peak
resp.	respective
	to be continued on next page

Abbreviation	Meaning
1oo2	1 out of 2 voting logic
1oo3	1 out of 3 voting logic
2oo2	2 out of 2 voting logic
2oo3	2 out of 3 voting logic

1.3. System Applications and Definitions

1.3.1. System Applications

Protection of rotating machinery such as turbines, expanders, compressors and motors with safety requirements SIL2/IEC61508 resp. DIN EN ISO 13849:2008 Cat.3 PLe and/or API 670 versus Overspeed and other Critical Conditions.

1.3.2. Definitions

The E16x446 system incorporates one Testgenerator type E1697 and three Monitors (A, B and C) type E1665 for evaluation of speed signals and external trip signals.

The logic blocks of the monitors for the evaluation of the external trip signals are named "Voter".

Each of the monitors represents a "channel" (A,B,C) for the processing of the speed signals and the external trip signals.

The logic results of the three channels are connected internally to form three 2oo3 trip circuits I, II and III which are named "Trip-Lines".

The Trip-Lines can be connected for example to a 1oo2 or 2oo3 solenoid valve block .

A released trip status of the Monitors respective of the complete system E16x446 can be latched, this function is named "Trip-Lock".

Trip is released by shut down of the Trip Circuits (Trip-Lines) to the solenoid valve block if:

- 2oo3 Monitors detect Overspeed condition
- 2oo3 sensor signals are detected as faulty by Monitors
- 2oo3 Monitors detect External Trip-Condition via Voters (1oo2, 2oo2, 2oo3 or 3oo3 selectable)

1.4. Key Features of System E16x446

Trip Release Function is SIL2/IEC61508 compliant as stand alone unit (without external testing by DCS or by operator).

Total Response Time to Trip Condition: < 15 milliseconds

Maximum Safety at Maximum Availability by :

- TMR (Triple Modular Redundancy) with three Monitors E1665
- Triple speed measurement and evaluation by each Monitor
- Variable overspeed alarm depending on acceleration
- Monitoring versus Lowspeed as protection versus incorrect mounting or malfunction of speed sensors
- Permanent monitoring of speed sensors
- Evaluation of external Trip-Condition signals by voters in each monitor. Response to signals selectable for each voter individually (Logic function, low/high: trip, response time).
- Permanent monitoring of monitors by Test-Generator with cyclic full automatic tests or externally triggered tests
- Permanent monitoring of 2oo3 Solenoid Valve Block by Test-Generator with cyclic full automatic or externally triggered tests
- Each Trip Line (trip circuit) in 2oo3 technique
- Trip Lines I, II, III, IV, V, VI are formed by safety relays with force guided contact sets
- Trip-Line-Monitoring with Trip-Lock Function (selectable)
- The outputs of the Trip Lines to the 2oo3 Solenoid Valve Block are permanently monitored. If the Trip-Lock Function is engaged, a trip condition is detected and locked if 2oo3 trip lines are in trip condition

Additional features of the E16x446-System:

- Remote test of solenoid valve block by test signals from DCS possible
- Display in each module for measured values and diagnostics
- Alarm outputs via opto-relays to DCS
- Free extra alarm from each monitor
- Up to 6 speed setpoints with 2oo3 logic outputs (if voters are not required)
- Sensor signal repeater outputs, free floating and push/pull
- Optional Analog Output (to represent the speed) 0/4..20 ma for each monitor
- Direction alarm (only with sensors type A5S with direction output)
- Parameters may be set by front keys (protected by code-digit) or by RS232-Interface

1.5. Ordering Key for Systems E16x446.abc

E16x446.abc

- c = 1** : Speed Signal Inputs and power supply for A5S sensors
- c = 2** : Speed Signal Inputs and power supply for Eddy Current Sensors
- c = 3** : Speed Signal Inputs for MPU (magnetic pick up)

- b = 1** : 1 Voter in each Monitor for external trip release condition
- b = 2** : 6 Voters in each Monitor for external trip release conditions

- a = 0** : without Analog Output (to represent the speed)
- a = 1** : 1 Analog Output in each Monitor A, B, C
- a = 2** : 1 Analog Output rated SIL2 in each Monitor A, B, C

- x = A** : Surface Mount Version
- x = E** : 19-Inch Rack File
- x = G** : Nema 4 Version with front window (surface mount)

Example:

- E16A446.021 : Surface Mount Version, without Analog Output, with 6 Voters, Speed Signal Inputs and power supply for A5S sensors
- E16A446.112 : Surface Mount Version, with Analog Output, with 1 Voter, Speed Signal Inputs and power supply for eddy current sensors
- E16A446.013 : Surface Mount Version, with 1 Voter, Speed Signal Inputs for MPU

1.6. Compliance

1.6.1. Compliance with IEC61508; SIL2

The E16x4xx is compliant with IEC61508; SIL2 as a stand alone TMR Trip-System for Over-speed Protection and Voters for external Trip Release Conditions, such as emergency stop, boiler protection etc.

1.6.2. Reseved

1.6.3. Reserved

1.7. Safety Data

1.7.1. Safety Data IEC61508; SIL2

System Type B; HFT = 1; Architecture 2oo3, Service Time 20 years

PFDavg = $2,51 \cdot 10^{-5}$ at T1 (Proof Check Interval) = 20 years

SFF = 96,7%

1.7.2. Reserved

2. System Structure and I/Os

2.1. System Structure

The structure of the system is shown in chapter **2.1.4.** (figures 2 and 3).

The wiring of the system is shown in chapter **2.1.5.** (figures 4 ,5 and 6).

The indexes "see 2.x.x" in these figures refer to the corresponding chapters 2.x.x. which describe the according functions.

2.1.1. Speed Sensors

With versions E16x446.xx1:

Three A5S Differential-Hall-effect sensors, with integrated signal amplifier are placed at the machine shaft.

The Differential Hall-effect sensors A5S are not susceptible to uniform external magnetic fields. Air gap variations between machine and sensor do not create false signals.

With versions E16x446.xx2:

Three Speed signals from Eddy Current Sensors are evaluated.

With versions E16x446.xx3:

Three Speed signals from MPU Sensors are evaluated.

2.1.2. System Components

The system comprises three Monitors E1665 for speed monitoring and for monitoring of the external trip conditions.

The Test-Generator E1697 checks and validates the performance of the monitors, of the Trip-Lines and of the 2oo3 solenoid valve block by tests.

The Monitors and the Test-Generator are connected via a backplane. The backplane does not hold any active components.

2.1.3. System Design

The system is available

- as 19-Inch Rack File, 3HE 84TE (E16E446) or
- for surface mounting (E16A446) or
- as NEMA4 version (E16G446).

2.1.4. System Structure Diagrams

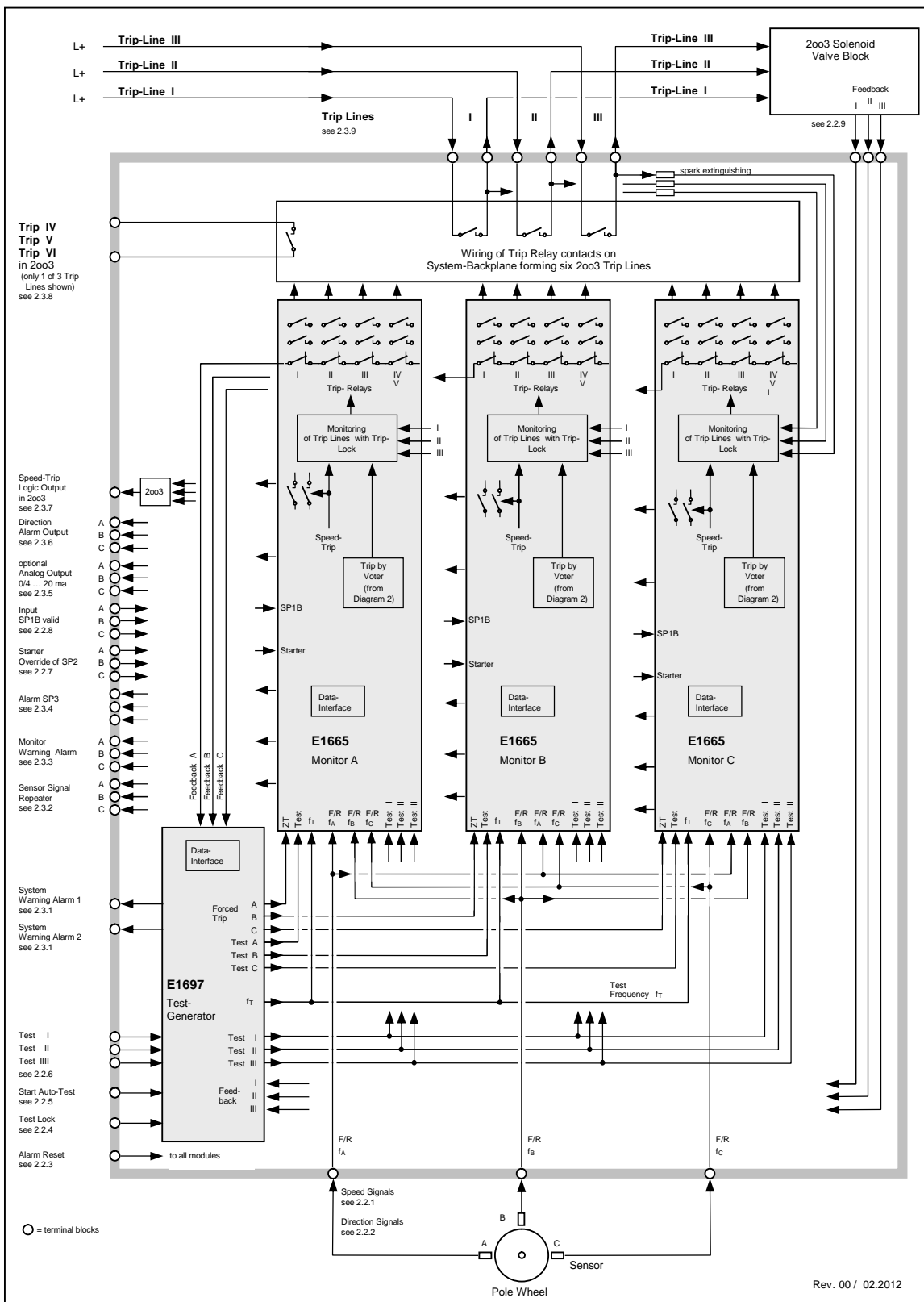

Figure 2: E16x446 System Structure Diagram 1 of 2

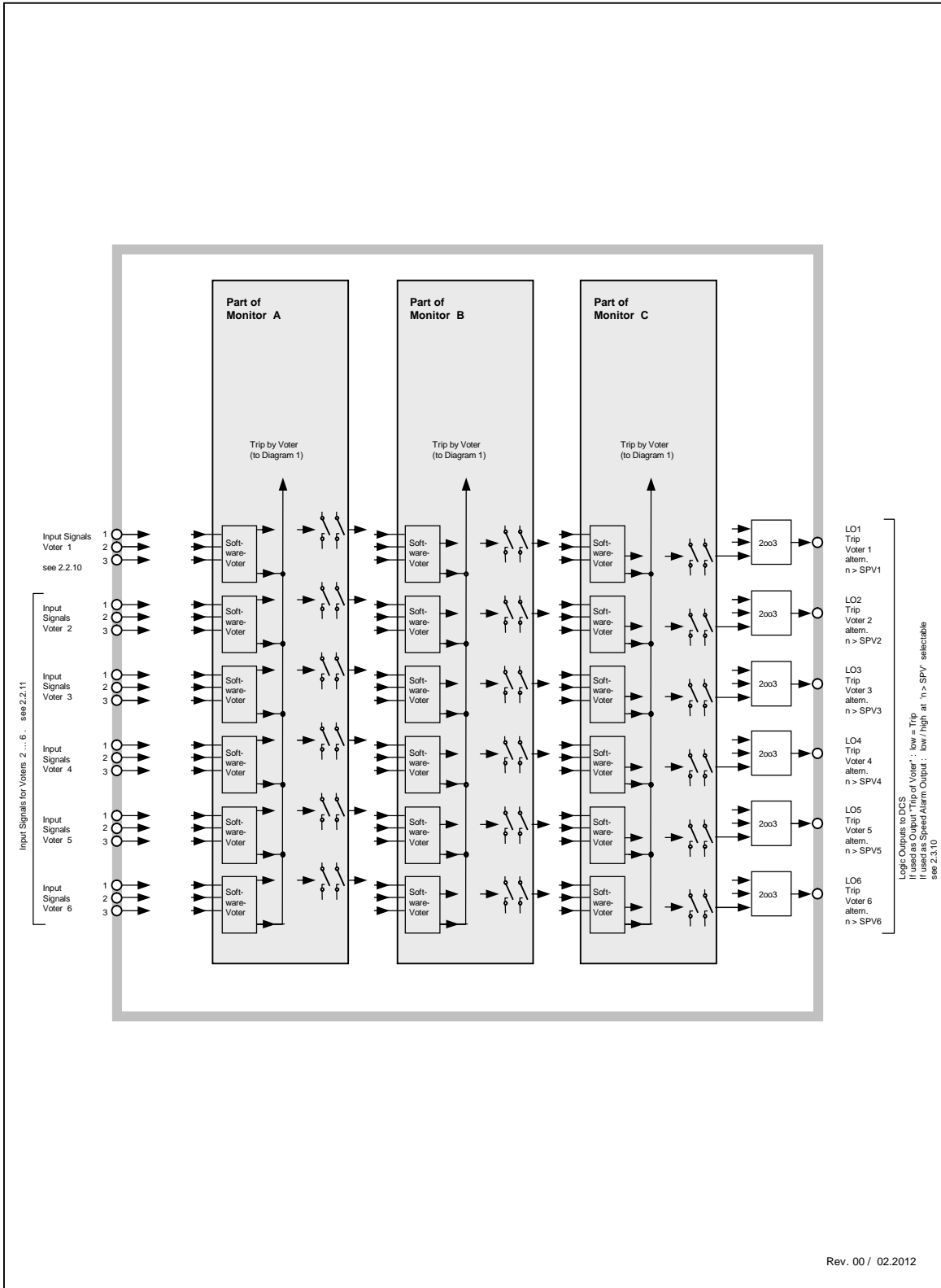

Figure 3: E16x446 System Structure Diagram 2 of 2

2.1.5. System Wiring Diagrams

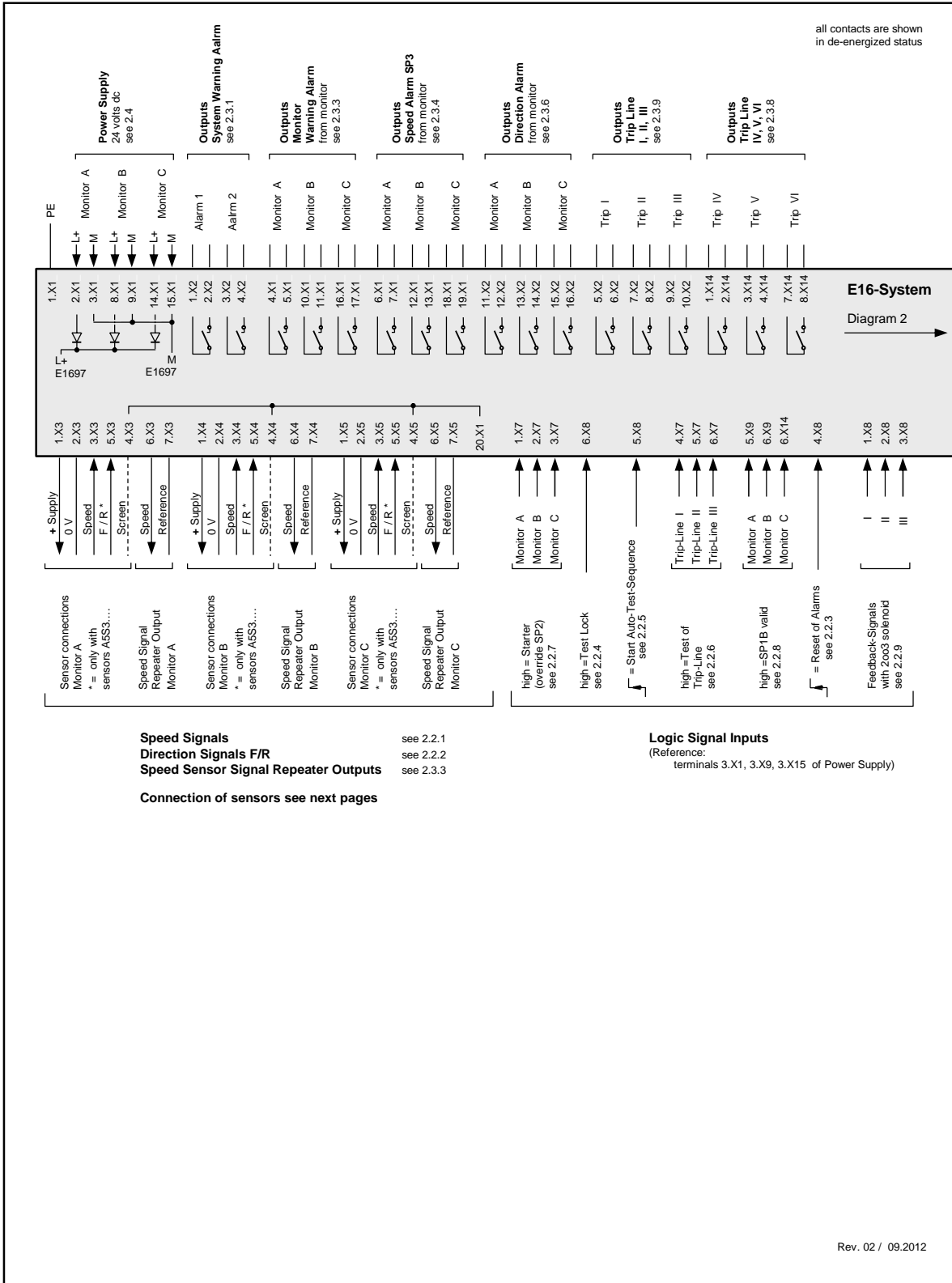

Figure 4: E16x446 System Wiring Diagram 1 of 3

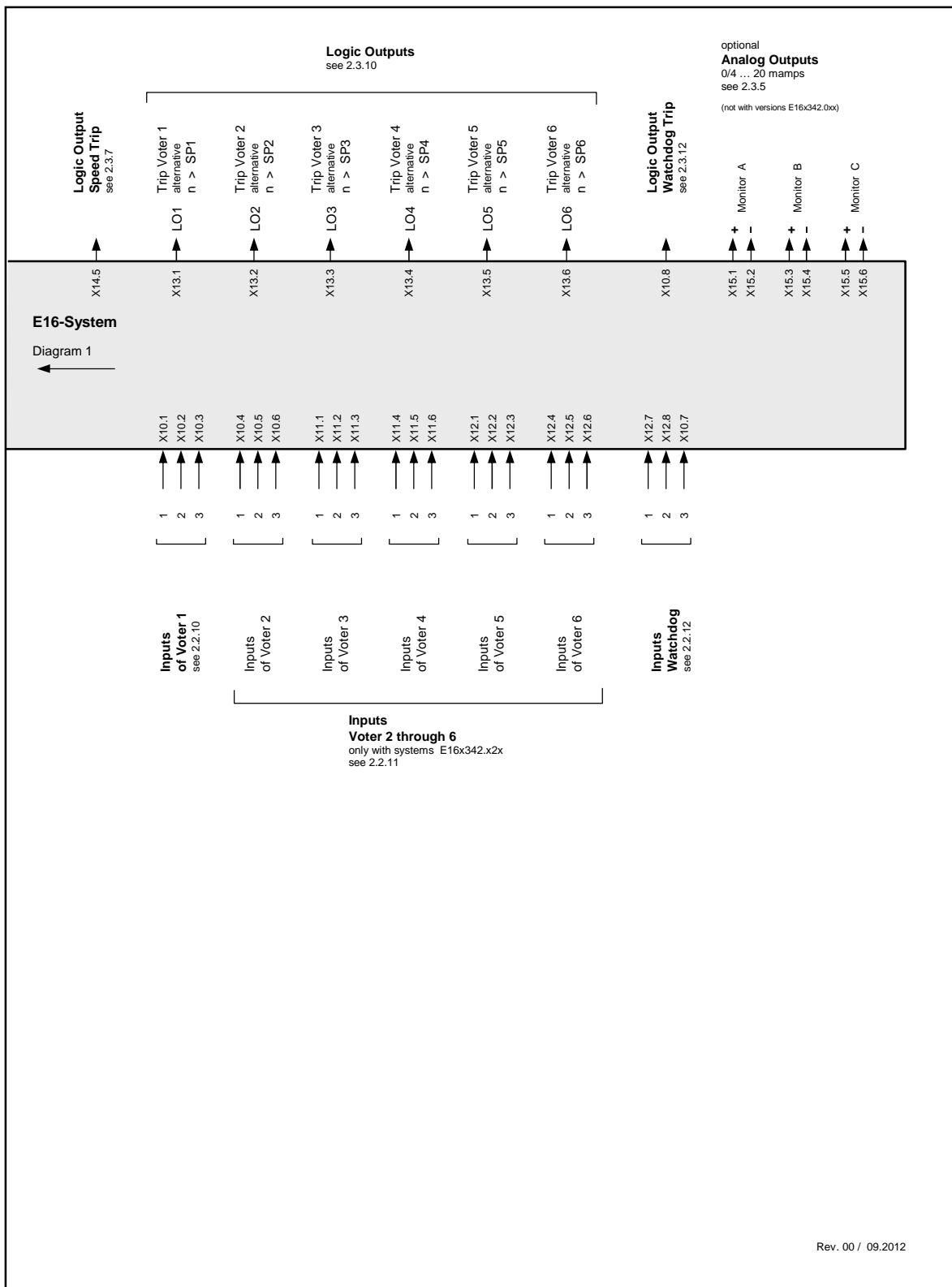
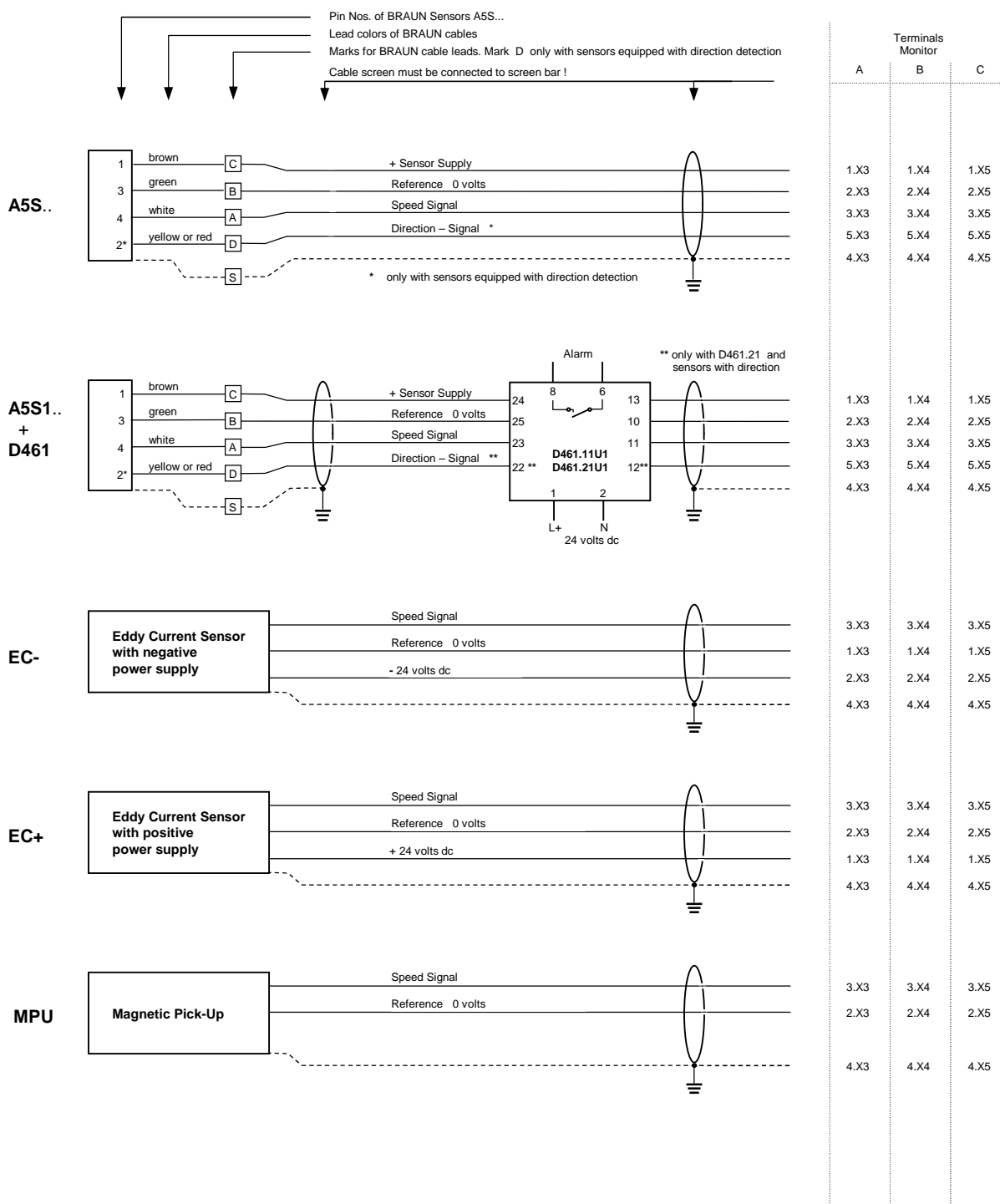

Figure 5: E16x446 System Wiring Diagram 2 of 3

2.1.6. Connection of Sensors to the Speed Signal Inputs



Rev. 00 / 09.2012

Figure 6: E16x446 System Wiring Diagram 3 of 3

2.2. Inputs of the System

2.2.1. Speed Signal Inputs

The speed signals are internally wired to all three Monitors in parallel for systems with speed signal inputs for A5S sensors.

With versions E16x446.xx1:

The speed signal inputs match the values of sensors A5S...

The speed signal inputs are rated SIL2/IEC61508 if sensors of type A5S. (also via barriers D461) are connected. For other sensors this is only valid, if the sensor supplier guarantees, that the sensors will not give erratic speed signals due to a common cause failure. The instructions of the sensor supplier must be observed.

Technical Data of inputs see 3.1.1.1.

With versions E16x446.xx2:

The signal inputs match the values of eddy current sensors.

The speed signal inputs are rated SIL2/IEC61508, if the sensor supplier guarantees, that the sensors will not give erratic speed signals due to a common cause failure. The instructions of the sensor supplier must be observed.

Technical Data of inputs see 3.1.1.2.

With versions E16x446.xx3:

The signal inputs match the values of MPUs.

The speed signal inputs are rated SIL2/IEC61508, if the sensor supplier guarantees, that the sensors will not give erratic speed signals due to a common cause failure. The instructions of the sensor supplier must be observed.

Technical Data of inputs see 3.1.1.2.

2.2.2. Direction Signal Inputs (F/R : Forward/Reverse)

The direction signal inputs match the values of BRAUN sensors A5S with incorporated direction detection.

The direction signals are internally wired to all three Monitors in parallel.

The direction signal inputs are rated SIL2/IEC61508 (valid only for sensors A5S..).

Technical Data of inputs see 3.1.2.

2.2.3. Input Reset of Alarms

The Reset signal is internally connected to all modules in parallel. It resets a no longer prevailing, but latched alarm or trip condition.

A signal transition from low to high will reset a latched alarm.

Minimum Time of Reset Signal: > 1 second to ensure correct reset of all modules.

The input "Reset of Alarms" is rated SIL2/IEC61508 provided that the signal source is rated SIL2/IEC61508.

Technical Data of input see 3.1.3.

2.2.4. Input Test Lock

A high signal will cancel a running test and inhibit further tests as long as the signal is high. If the signal is true for more than 60 minutes, the alarms System Warning 1 and System Warning 2 are released.

The input "Test Lock" is rated SIL2/IEC61508 provided that the signal source is rated SIL2/IEC61508.

Technical Data of input see 3.1.3.

2.2.5. Input Start Auto-Test-Sequence

A signal transition from low to high will start an Auto-Test-Sequence. First the test (if selected, see step P03.01 of E1697) of the trip lines for the solenoid valve block is performed, two minutes later the test of the Monitors is performed.

The input "Start Auto-Test-Sequence" is rated SIL2/IEC61508 provided that the signal source is rated SIL2/IEC61508.

Technical Data of input see 3.1.3.

2.2.6. Inputs Test I, Test II, Test III

The inputs Test I, II, III are enabled, if the Test-Generator E1697 is programmed to external Trip-Line Test (see parameter P03.01 of E1697).

If the input is high, the corresponding Trip-Line will switch to trip condition.

The inputs may be configured to inhibit simultaneous test of two or three trip lines.

The input "Test I, II, III" are rated SIL2/IEC61508 provided that the signal source is rated SIL2/IEC61508.

Technical Data of inputs see 3.1.3.

2.2.7. Inputs Starter (Override of SP2)

Each Monitor has one input for the starter condition. As long as the input is high, the starter condition is true.

During starter condition the monitoring versus lowspeed (SP2) is disabled.

The inputs "Starter" are rated SIL2/IEC61508 provided that the signal source is rated SIL2/IEC61508.

Technical Data of inputs see 3.1.3.

2.2.8. Inputs SP1B valid

Each Monitor has one input to select SP1B as trip setpoint.

As long as the input is high, setpoint value SP1B (see step P03.03 of E1665) is true.

With open input (low), setpoint value SP1A (see P03.00 of E1665) is true.

The inputs "SP!B valid" are rated SIL2/IEC61508 provided that the signal source is rated SIL2/IEC61508.

Technical Data of inputs see 3.1.3.

2.2.9. Inputs Feedback from Solenoid Valve Block

The feedback inputs are connected to the Test-Generator E1697.

The inputs are only monitored if the auto test mode for Trip-Line Test resp. test of solenoid valve block is selected (see step P03.01 of E1697).

The signal truth level (high or low as trip condition) is selectable (see step P03.03 of E1697).

The inputs "Feedback from Solenoid Valve Block" are rated SIL2/IEC61508 provided that the signal source is rated SIL2/IEC61508.

Technical Data of input see 3.1.3.

2.2.10. Inputs for Voter 1

The input signals for Voter 1 are internally connected to all Monitors in parallel.

The input load of Voter 1 meets the requirements for the redundant outputs of a failsafe PLC (load > 45 ma per input).

The signal truth level (high or low as trip condition), the voting principle (1oo2, 2oo2, 2oo3, 3oo3) and the response time is selectable. Configuration of the voter is done in steps P10.xx of E1665.

The inputs "Voter 1" are rated SIL2/IEC61508 provided that the signal source is rated SIL2/IEC61508.

Technical Data of inputs for Voter 1 see 3.1.4.

2.2.11. Inputs for Voters 2 ... 6

The input signals for Voters 2 ... 6 are internally connected to all Monitors in parallel.

The signal truth level (high or low : trip condition), the voting principle (1oo2, 2oo2, 2oo3, 3oo3) and the response time is selectable for each voter individually. Configuration of voters is done in steps P11.xx to P15.xx of E1665.

The inputs "Voter 2...6" are rated SIL2/IEC61508 provided that the signal source is rated SIL2/IEC61508.

Technical Data of inputs for Voter 2 ... 6 see 3.1.3.

Note:

Systems E16x446.x1x do not have inputs for Voters 2 ... 6 .

2.2.12. Inputs for Watchdog

The input signals for the Watchdog are internally connected to all monitors in parallel.

Configuration of the Watchdog is done in step P02.00.

The duration time of the Watchdog pulse signal must be minimum 100 milliseconds, signal may be a positive pulse or a negative pulse (minimum low time = minimum high time = 100 milliseconds).

The inputs "Watchdog" are rated SIL2/IEC61508 provided that the signal source is rated SIL2/IEC61508.

Technical Data of inputs for Watchdog see 3.1.3

2.3. Outputs of the System

2.3.1. Outputs System Warning Alarm 1 and System Warning Alarm 2

The System Warning Alarm 1 and System Warning Alarm 2 from Testgenerator E1697 are released if:

- a Monitor does not show correct response
- a Monitor releases a sensor fault alarm
- the feedback signals from the solenoid valve block do not show correct response (if monitored)
- one or more Monitors signalize a nonconformity of their voter inputs

If the System Warning Alarm 1 and System Warning Alarm 2 do not have the same status, the Test-Generator E1697 itself has a malfunction.

The outputs "Warning Alarm 1" and "Warning Alarm 2" are rated SIL2/IEC61508.

Technical Data of outputs see 3.2.3.

2.3.2. Speed Signal Repeater Outputs

Each Monitor repeats the speed signal of its main sensor (Monitor A repeats sensor signal A) to the periphery.

The Speed Signal Repeater Outputs are rated SIL2/IEC61508.

Technical Data of outputs see 3.2.1.

2.3.3. Outputs Monitor Warning Alarm

The Monitor Warning Alarm (for each Monitor individually) is released if at least one of the following conditions is true:

- Monitor releases trip (due to overspeed resp. voter), if selected
Selection in step P02.11 of E1665
- Deviation of its own sensors versus both sensors of neighbor Monitors, if monitored
Selection in steps P02.07 through P02.09 of E1665
- Measured speed lower than SP2 (after starter condition), if monitored
Selection in step P02.06 of E1665
- Sensor Circuit Fault, if monitored
Selections in steps P02.04 and P02.05 of E1665
- If starter condition is still true and speed exceeds 50% of nominal speed (as set in step P01.03), if selected in step P02.06

Note:

The Monitor Warning Alarm is not released, if the Monitor detects a nonconformity at its voter inputs. This status is forwarded to the Testgenerator E1697 which then releases System Warning Alarm 1 and System Warning Alarm 2.

The outputs "Monitor Warning Alarm" are rated SIL2/IEC61508.

Technical Data of outputs see 3.2.3.

2.3.4. Outputs Speed Alarm SP3

Each Monitor has a free adjustable speed alarm output SP3.

Configuration of SP3 in steps P05.xx of E1665.

The outputs "Speed Alarm SP3" are rated SIL2/IEC61508.

Technical Data of outputs see 3.2.3.

2.3.5. Analog Outputs for measured speed (Option)

The (optional) analog outputs have a range of 0/4 .. 20 milliamps.
Configuration of the analog output in steps P08.xx of E1665.
The analog outputs of versions E16x446.1xx are rated SIL2/IEC61508.
The analog outputs of Monitors E16x446.2xx are rated SIL2/IEC61508.
Technical Data of outputs see 3.2.2.

2.3.6. Outputs Direction Detection

If operated with sensors A5S with direction signal, the sense of direction is signalized.
Each Monitor votes the direction input signals 2oo3. Each Monitor has a direction detection output.
The outputs "Direction Detection" are rated SIL2/IEC61508.
Technical Data of outputs see 3.2.3.

2.3.7. Speed Trip Logic Output (2oo3 voted)

Speed Trip Logic Output is released, if minimum 2 of the 3 monitors detect overspeed condition. If overspeed status is latched, the alarm will persist until reset.
Output high : no overspeed trip
Output low : overspeed trip
The Speed Trip Logic Output is rated SIL2/IEC61508.
Technical Data of output see 3.2.4.

2.3.8. Outputs Trip-Lines IV, V, VI

The Trip-Lines IV, V, VI are 2oo3-circuits formed by contacts of safety trip relays IV and V of Monitors A,B,C.
Trip is released if minimum two Monitors E1665 are in trip status.
Trip-Lines IV, V, VI are intended to signalize the trip to a DCS or PLC.
The outputs of Trip-Lines IV, V, VI are rated SIL2/IEC61508.
Technical Data of output see 3.2.5.

2.3.9. Outputs Trip-Lines I, II, III

The Trip-Lines I, II, III are 2oo3-circuits formed by contacts of safety trip relays of Monitors A,B,C.
Trip is released if minimum two Monitors E1665 are in trip status.
Trip-Lines I, II, III are intended to supply shutdown solenoid valves.
The outputs of Trip-Lines I, II, III are rated SIL2/IEC61508.
Technical Data of output see 3.2.6.

2.3.10. Logic Outputs LO1 through LO6 (voted 2oo3)

The logic outputs LO may be assigned to signalize a voter trip or to a speed alarm.
If assigned to Voter Trip: Output high : no trip of Voter
Output low : trip of Voter
If assigned to speed alarm: Output high/low if n > SP is selectable.
The Logic Outputs LO1 through LO6 are rated SIL2/IEC61508.
Technical Data of outputs see 3.2.4.

2.3.11. Reserved

2.3.12. Logic Output Watchdog (voted 2oo3)

The Logic Output Watchdog goes low, if a trip is released due to missing Watchdog input signals.

The Logic Output Watchdog is rated SIL2/IEC61508.

Technical Data of output see 3.2.4.

2.4. Power Supply

Each Monitor must be supplied with 24 volts dc (18..40 volts) from a power supply with protective separation (SELV or PELV), conforming to IEC 61131-2 requirements.

The Test Generator E1697 is fed by an internal power rail.

Technical Data see 3.3.

2.5. Data-Interface

Each of the Monitors E1665 and the Testgenerator E1697 carry a 9pole Sub-D-connector (female). Implemented on this connector are a Profibus-Interface (with standard-pinning) and a RS232-Interface (non standard pinning).

2.5.1. Profibus-Interface for Status and Diagnostics of the System

The Profibus-Interface reflects the standard Profibus DP and serves for the upload of status and diagnostics of the system to a PLC or DCS.

2.5.2. RS232-Interface for Setting of Parameters

The RS232-Interface in conjunction with the Interface-Software IS-RS232-E16 serves to download parameter values from a PC to the E16 and to retrieve parameter values from the E16 to a PC. The data communication in between the E16 and the PC is failsafe and fulfills SIL2/IEC61508 requirements.

3. Technical Specifications

3.1. Technical Data of Inputs

3.1.1. Technical Data of Speed Signal Inputs

3.1.1.1. Hall Sensor Inputs

Maximum Input Frequency : 30 kHz

Maximum Signal Voltage : 30 volts

Input low at : < 3 volts

Input high at : > 7 volts

Impedance : approx. 5 kohms

Minimum pulse high time: 20 microseconds

Minimum pulse low time: 20 microseconds

Sensor Supply : approx. 13 volts, maximum 80 ma

The speed signal inputs have the same reference but are free floating versus all other circuits.
The inputs are fed by an internal isolated power supply of the Monitor.

3.1.1.2. Eddy Current Sensor Inputs resp. MPU (Magnetic Pick-Up) Inputs

Maximum Input Frequency : 30 kHz

Maximum Signal Voltage : 30 volts

Trigger Hysteresis : 0.07 to 2.5 Vpp

Impedance : approx. 47 kohms

Sensor Supply (only with versions E16x446.xx3): approx. 24 volts, maximum 120 ma

The speed signal inputs have the same reference but are free floating versus all other circuits.
The input is supplied by an internal isolated power source of the Monitor.

3.1.2. Technical Data of Direction Inputs

Maximum Signal Voltage : 30 volts

Input low at : < 3 volts

Input high at : > 7 volts

Impedance : approx. 22 kohms

Same Reference as Speed Signal Inputs.

3.1.3. Technical Data of Binary Inputs (excluding Voter 1)

Input high : 18..48 volts (nominal current at 24 volts: 6 ma)

Input low : < 3 volts or open input

Reference : negative pole of power supply

3.1.4. Technical Data of Binary Inputs of Voter 1

Input high : 18..30 volts (nominal current at 24 volts: 45 ma)

Input low : < 3 volts or open input

Reference : negative pole of power supply

3.2. Technical Data of Outputs

3.2.1. Technical Data of Sensor Signal Repeater Outputs

High-Level : > 20 volts with max. load, (maximum 26 volts without load)

Low-Level : < 2 volts, with max. load

Maximum load: 1 kohms

The outputs are short-circuit proof and free floating (also versus each other).

The output is supplied by an internal isolated power source of the Monitor.

3.2.2. Technical Data of Analog Outputs

Range : 0/4...20 ma

Resolution : 12 Bit

Maximum load : versions E1665.1xx : 650 ohms, versions E1665.2xx : 400 ohms

Linearity event : < 0.1%

Temperature stability : $\pm 0,02$ %/°C within a range of 0...60°C.

The outputs are short-circuit proof and free floating (also versus each other).

The output is supplied by an internal isolated power source of the Monitor.

3.2.3. Technical Data of Opto-Relay Outputs

Maximum rating : 50 volts dc / 50 ma.

Outputs are passive, short-circuit proof and free floating (also versus each other). They must be supplied externally.

Note:

In case of short circuit the output is latched to tristate until power supply of the monitor has been switched off and on.

3.2.4. Technical Data of Logic Outputs

The outputs are fed from the system power supply.

Reference : L- (negative pole of power supply).

High-Level : Power supply L+ minus 2 volts

Low-Level : < 3 volts

Maximum output current : 50 milliamps

Outputs are short-circuit proof.

Note:

In case of short circuit the output is latched to tristate until power supply of the monitor has been switched off and on.

3.2.5. Technical Data of Trip-Lines IV, V, VI

Maximum rating : 50 volts dc / 300 milliamps.

Outputs are passive, short-circuit proof and free floating. They must be supplied externally.

3.2.6. Technical Data of Trip-Lines I, II, III

Maximum rating : 50 volts dc / 3 amps / 75 watts

Maximum rating for DC13-applications : 24 volts / 3 amps

Outputs are not short-circuit proof (permanent currents exceeding 8 amps will destroy outputs).

Recommended primary fuse rating: 3 amps nominal with max. 6 amps release current.

Impedance: 10 kohms versus L- (negative pole of power supply)

For inductive type loads, external spark extinguishing means must be provided.

Total response time (trip relays de-energize to trip) from trip event until trip circuits are in trip condition : < 15 milliseconds.

3.3. Technical Data of Power Supply

3x 24 volts dc / 0.5 amps (18...40 volts) from a power supply with protective separation (SELV or PELV), conforming to IEC 61131-2 requirements.
Maximum consumption of system : 20 watts

3.4. Installation Conditions

Ambient temperature in operation : 0°C..+55°C
Ambient temperature in storage : -20°C..+85°C
Relative humidity: < 75%, non-condensing
To be installed in dry cabinets in air-conditioned rooms

3.5. Protection Grade

Insulation Class III
Version E16A446 and E16E446 : IP20
Version E16G446: IP65 resp. NEMA4

3.6. Connectors

Plug-In Cage-Clamp Connectors, type Phoenix Combicon FK-MLP1,5/...ST-3,5,
fitting for:

Conductor cross section solid min.: 0.2 mm²
Conductor cross section solid max.: 1.5 mm²
Conductor cross section stranded min.: 0.2 mm²
Conductor cross section stranded max.: 1.5 mm²
Conductor cross section stranded, with ferrule without plastic sleeve min.: 0.25 mm²
Conductor cross section stranded, with ferrule without plastic sleeve max.: 1.5 mm²
Conductor cross section stranded, with ferrule with plastic sleeve min.: 0.25 mm²
Conductor cross section stranded, with ferrule with plastic sleeve max.: 0.75 mm²
Conductor cross section acc. to AWG/kcmil min.: No. 24
Conductor cross section acc. to AWG/kcmil max: No. 16
Minimum AWG according to UL/CUL: 28
Maximum AWG according to UL/CUL: 16

3.7. Conformity to Standards

2006/42/EU
SIL2/IEC61508, API 670,
2006/95/EU, EN 61010-1,
2004/108/EU, EN 61000-6-2, EN 61000-6-4, IEC 61326-2

3.8. Dimensions of System E16A446

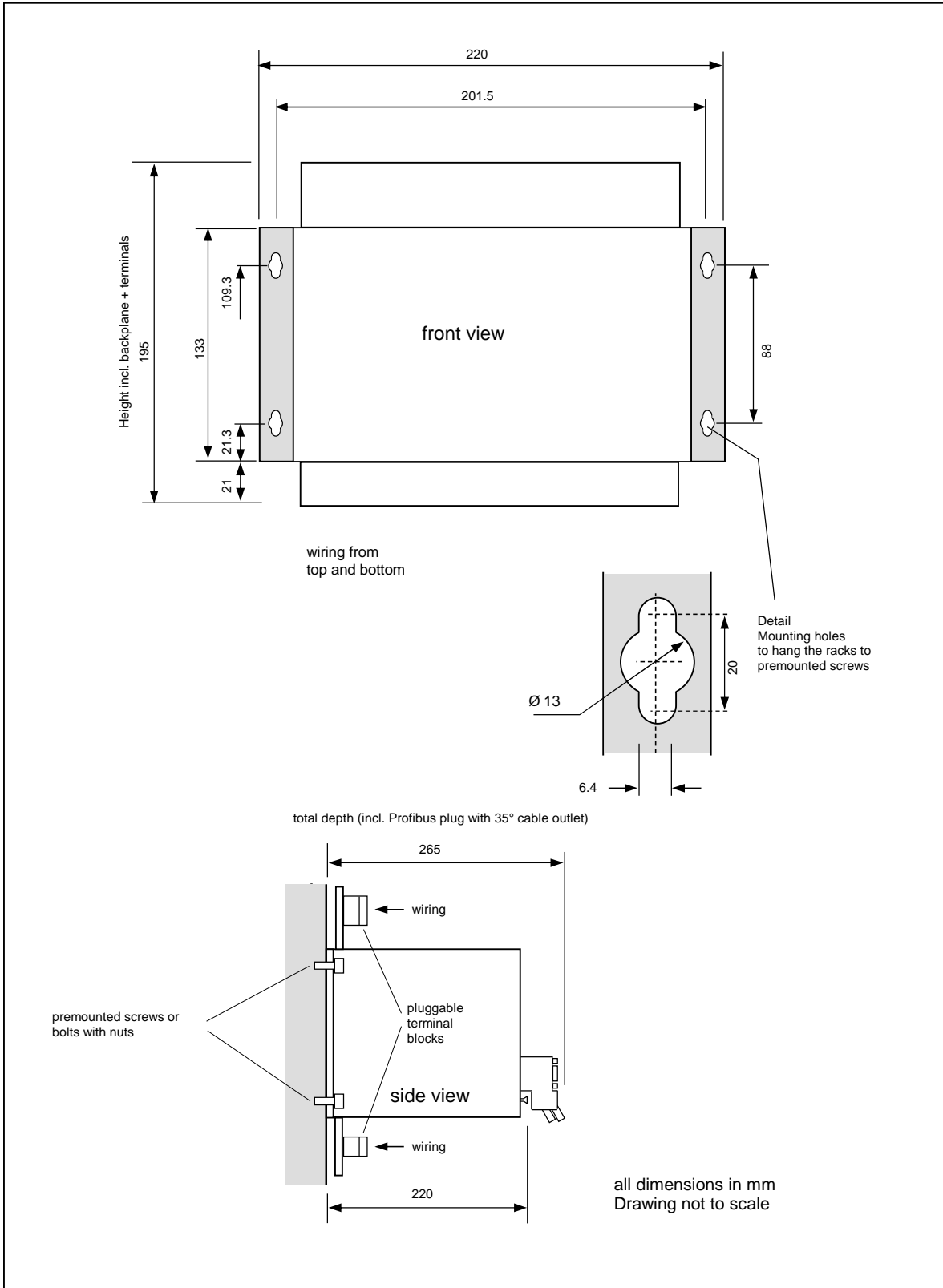

Figure 7: Dimensions of System E16A446

3.9.

Dimensions of System E16E446

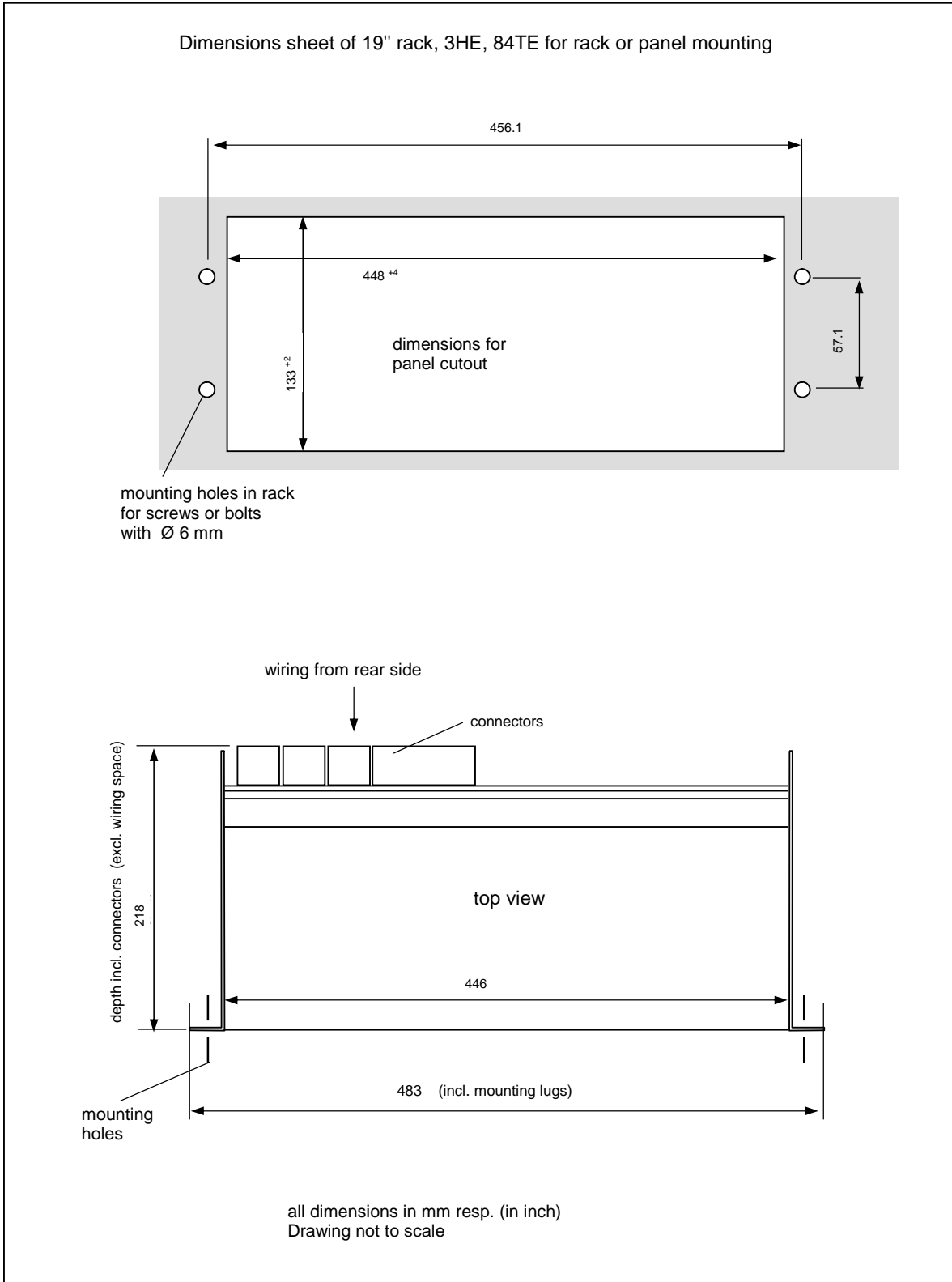

Figure 8: Dimensions of System E16E446

3.10. Dimensions and Features of E16G446 Enclosure

Overall Dimensions (including mounting lugs):

Height: 510 mm

Width: 410 mm

Depth: 270 mm

Glazed Window with size 360 by 410 mm

Material: Fiberglass reinforced plastic

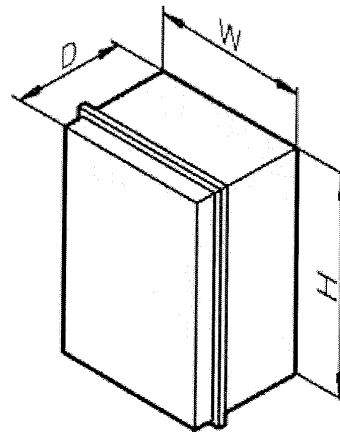

Figure 9: Dimensions of E16G446 Enclosure

3.11. Weight of E16x446

E16A446 : 3,0 kg

E16E446 : 3,7 kg

E16G446 : 13,0 kg

3.12. Material specifications of E16A446 or E16E446

Housing: Aluminium

Front panels and back panel: Lexan or. FR4 (min. V-1 by UL)

4. Safety Notes for Installation and Operation

4.1. Safety Notes for Installation

This unit has been designed and inspected according to standards DIN EN 61010-1 (VDE 0411-1). Observe these instructions and wiring diagrams carefully, to ensure this protection. The installation must be done only by adequately qualified personnel.

4.1.1. General Instructions

Specifically, connect the PE terminal 1.X1 to a safe ground potential.

Do not open the instrument. Connections and all programming are done from outside. When removing it from its enclosure however, from whatever reason, make sure that power is switched off.

The instrument may be installed in any position, but not in the immediate neighborhood of interfering sources.

Signal leads must be carefully shielded, and should not be run in bundles with power or relay control leads.

4.1.2. EMI

The unit complies with all relevant regulations, as determined by the Policy of the European Committee for Electrotechnical Standardization (CENELEC), for the Electromagnetic Compatibility (2004/108/EU). Testing and inspection has been performed according to Standards EN 61000-4-2 and EN 61000-4-4. Thereby, the product meets all requirements to be marked by the CE sign.

Strict observance of these instructions during installation and use is an indispensable precondition hereto. Specifically to be observed:

Terminals must be kept off all undue access; power supply and all input and output leads must be protected against voltage interference, higher than specified operation data, and they must be protected against electrostatic discharge.

4.2. Safety Notes for Operation

4.2.1. Safety notes for commissioning

On initial operation of the monitored machine the operator must ensure proper function of the measurement chains. This includes checking of the correct speed display and of the trip release due to a real overspeed condition.

The parameter settings must be documented and protected against unauthorized changes.

5. Description of Monitor E1665

5.1. Display and Frontside Operational Elements

5.1.1. Front View of Monitor E1665

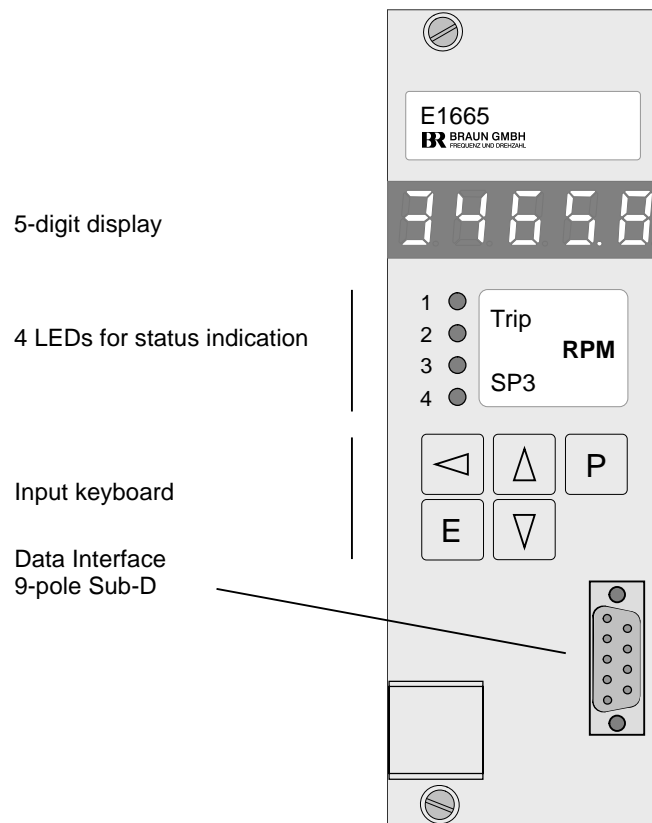

Figure 10: Front view of Monitor E1665

5.1.2. Status-LEDs

LED1	steady on:	Trip
LED2	steady on:	no Trip, SP1A is valid
	blinking:	SP1B is valid
LED3	steady on:	$n < SP3$
	blinking:	one only of three input channels measures zero speed
LED4	steady on:	$n > SP3$

5.1.3. Display during Test Procedures

- FC-1 : Frequency generator tests Input "Forced Trip"
- FC-3.1 : Trip-Line I is tested (relay I to Trip-Condition)
- FC-3.2 : Trip-Line II is tested (relay II to Trip-Condition)
- FC-3.4 : Trip-Line III is tested (relay III to Trip-Condition)

5.1.4. Values accessible during normal operation

Values accessible during normal operation (Standard Display Mode):

- with key Δ the value of SP1
- with key ∇ the value of SP2
- with key Δ and E together: maximum stored speed value,
- with key ∇ and E together: minimum stored speed value.

Note:

- with key \leftarrow : reset of stored minimum/maximum value reset
- with keys \leftarrow and E together: reset of non persistent events (if enabled)
- with keys Δ and ∇ together: toggle between Standard and Special Display Mode 1
- with keys Δ and P together: toggle between Standard and Special Display Mode 2

5.1.5. Display of Firmware release state and CRC-Parameter-Checksum of Monitor

with key P pressed longer as 5 seconds, the firmware release state and the CRC-Parameter-Checksum will be shown in a scrolled display:

A.0327 (firmware ID)
U._ _xx (xx = firmware version number)
D.uu_ _ (uu = year)
D._vv_ (vv = month)
D._ _ww (ww = day of firmware release state)
C.abcd (abcd = CRC-Parameter-Checksum)

5.1.6. Special Display Mode 1

Toggle between Standard and Special Display Mode 1 by pressing keys Δ and ∇ together. In Special Display Mode 1 the measured speed values of sensors A, B, C can be shown individually as well as the actual level of the main sensor signal input.

Toggle between the four values with E .

The LED assigned to the specific speed value is blinking (see table).

with Monitor	LED assigned to			
	speed value of sensor: LED1 LED2 LED3			actual signal input level (in xx.x volts): LED4
A	A	C	B	A
B	B	A	C	B
C	C	B	A	C

5.1.7. Special Display Mode 2

Toggle between Standard and Special Display Mode 2 by pressing keys Δ and P together.

In Special Display Mode 2, LED1 and LED4 are blinking.

This display mode is only used for trouble shooting, if external signals are missing and the Monitor displays the event code E.0.4.0.0 .

5.1.8. Frontside Reset of Alarms and Event Codes

Resetting of (no longer valid) alarms and event codes is done by pressing keys E and \leftarrow (if enabled in step P00.02).

5.1.9. Data Interface

9pole Sub-D for PROFIBUS and RS232. See also chapter 7.3.

5.2. Functions of Monitor E1665

For a detailed description of the individual functions refer to chapter 8.

5.2.1. Speed Measurement

Each Monitor receives the signal from the three sensors and calculates the speed from each signal. For the further evaluation it selects (depending on parameter settings) the calculated speed value derived of its own sensor or the mean value of all three speed values.

Speed calculation is done by measuring the time in between the pulses. The minimum measurement time is 5 milliseconds.

To compensate for an imperfect gear, a predivider may be introduced to reduce the signal frequency to 1 pulse per revolution.

5.2.2. Functions for Overspeed Protection

Overspeed protection is done by :

- Monitoring of Sensors
- Monitoring versus Lowspeed as protection versus incorrect mounting or fault of speed sensors.
- Monitoring versus overspeed

5.2.3. Functions for External Trip by Voters

Trip is released, if one of the voters detects an external trip condition.

Voters may be configured as 1oo2, 2oo2, 2oo3 or 3oo3. High or low Input-Level as trip condition and response time is selectable.

5.2.4. Selftest of Monitor

Selftest is performed at an interval of 2 hours. Selftest of the Monitors are inhibited versus each other.

The Selftest routine includes

- CPU RAM-Test
- CPU EEPROM-Test
- CPU Command-Test
- CPU Register-Test
- Voter Signal-input-Test

If the Selftest detects a malfunction, the Monitor is set to trip-status.

6. Description of Test-Generator E1697

6.1. Display and Frontside Operational Elements

6.1.1. Front View of Test-Generator E1697

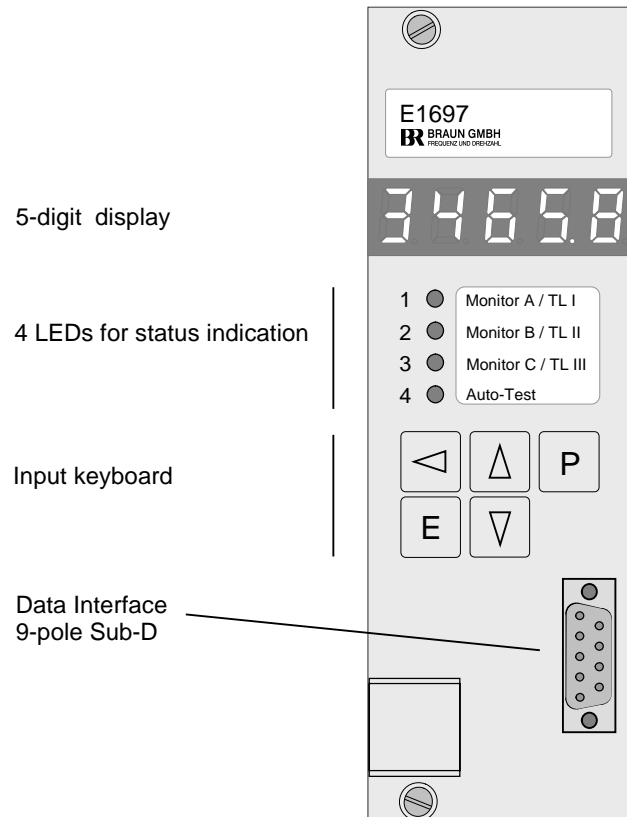

Figure 11: Front view of Test-Generator E1697

6.1.2. Status-LEDs

- LED1 blinking: Test of Monitor A resp. Trip-Line I
- steady on: Monitor A signalizes Trip
- LED2 blinking: Test of Monitor B resp. Trip-Line II
- steady on: Monitor B signalizes Trip
- LED3 blinking: Test of Monitor C resp. Trip-Line II
- steady on: Monitor C signalizes Trip
- LED4 blinking: LED4 blinking: Test in preparation
- steady on: Monitor-AutoTest-Mode on
- steady off: Monitor-AutoTest-Mode off

6.1.3. Display during Test Procedures

FC-1 : Frequency generator tests Input "Forced Trip"
FC-3.0 : Trip-Line Test in preparation
FC-3.1 : Test Generator is testing Trip-Line I (relay I of all Monitors to Trip-Condition)
FC-3.2 : Test Generator is testing Trip-Line II (relay II of all Monitors to Trip-Condition)
FC-3.4 : Test Generator is testing Trip-Line III (relay III of all Monitors to Trip-Condition)

FC-3.3 : Inputs Test I and II are active (but test is inhibited)
FC-3.5 : Inputs Test I and III are active (but test is inhibited)
FC-3.6 : Inputs Test II and III are active (but test is inhibited)
FC-3.7 : Inputs Test I and II and III are active (but test is inhibited)

FC-5.1 : Non-coincidence of test outputs detected.
FC-5.2 : Input Test Lock is active
FC-5.6 : Input Test Lock is longer than 10 minutes active

6.1.4. Values accessible during normal operation

with key Δ : the value of test-speed 1 resp. SP1A,
with key ∇ : the value of test-speed 2 resp. SP1B,
with keys ∇ and E together: time remaining (in XXXX.X minutes) till start of the next Monitor-Test-Sequence),
with keys Δ and E together: time remaining (in XXXX.X minutes) till start of the next Trip-Line-Test-Sequence).

6.1.5. Display of Firmware release state and CRC-Parameter-Checksum of Test-Generator

with key P pressed longer as 5 seconds, the firmware release state and the CRC-Parameter-Checksum will be shown in a scrolled display:

A.0339 (firmware ID)
U._ _xx (xx = firmware version number)
D.uu_ _ (uu = year)
D._vv_ (vv = month)
D._ _ww (ww = day of firmware release state)
C.abcd (abcd = CRC-Parameter-Checksum)

6.1.6. Frontside Reset of Alarms and Event Codes

Resetting of (no longer valid) alarms and event messages is done by pressing keys E and \leftarrow simultaneously.

6.1.7. Manual Start of a Monitor-Test Sequence

The test routine can be activated from the front of the test generator by pressing keys P and \leftarrow simultaneously.

6.1.8. Manual Start of a Trip-Line-Test Sequence

The test routine can be activated from the front of the test generator by pressing keys P and ∇ simultaneously.

6.1.9. Data Interface

9-pole Sub-D for PROFIBUS and RS232.
See also chapter 7.3.

6.2. Functions of Test-Generator 1697

For a detailed description of the individual functions refer to chapter 9.

6.2.1. Test of Feedback Signals

During normal operation the trip and alarm feedback signals of the Monitors and the Trip-Lines are permanently checked. If one or more Monitors or Trip-Lines are in alarm or trip status, the Test-Generator releases its alarm outputs "System Fault 1" and "System Fault 2".

Monitor Test and Trip-Line Test is inhibited during this status.

6.2.2. Monitor-Test Sequence

During the Monitor-Test Sequence each monitor is sequentially subjected to a test sequence consisting of two simulated test-speeds followed by a 'Forced Trip' signal.

Step 1: Each Monitor is sequentially provided with a test-speed 1 ($n > SP1$) to which the Monitor under test must respond with trip release.

Step 2: Each Monitor is sequentially provided with a test-speed 2 ($n < SP1$) to which the Monitor under test must not respond with trip release.

Step 3: The 'Forced Trip' control input of each Monitor is sequentially activated to which the Monitor under test must respond with trip release. During this step the Monitor is provided with test-speed 2 ($n < SP1$)

In the event of an incorrect response the test will be discontinued and the Test-Generator releases the System Warning Alarm 1 and 2.

If variable setpoint SP1var is active, the test may be optionally performed according to the following steps:

Step 1: Each Monitor is sequentially provided with a test-speed 1 ($SP1A + 5 \text{ RPM}$) to which the Monitor under test must respond with trip release.

Step 2: Each Monitor is sequentially provided with a test-speed 2 ($SP1B - 5 \text{ RPM}$) to which the Monitor under test must not respond with trip release.

Step 3: The 'Forced Trip' control input of each Monitor is sequentially activated to which the Monitor under test must respond with trip release. During this step the Monitor is provided with test-speed 2 ($SP1B - 5 \text{ RPM}$)

Step 4: Each Monitor is sequentially provided with a test-speed 3 ($SP1A - 5 \text{ RPM}$) to which the Monitor under test must not respond with trip release.

Step 5: Each Monitor is sequentially provided with a test-speed 4 ($SP1B + 5 \text{ RPM}$) to which the Monitor under test must respond with trip release.

The time interval of these tests is programmable (see P02.02). The test sequence may also be started by an external signal „Start Auto Test Sequence“ or manually via frontside keyboard of the Test-Generator.

6.2.3. Trip-Line-Test Sequence (Test of 2003 solenoid valve block)

The Test-Generator commands the Monitors to put sequentially the trip relays I, II or III to trip condition.

By doing so the designated Trip-Line to the solenoid valve is in trip condition. The condition of the 2003-solenoid valve must be passed back to the E16 system.

The testing of Trip-Line I must provide the response of Trip I.

The testing of Trip-Line II must provide the response of Trip II.

The testing of Trip-Line III must provide the response of Trip III.

In the event of an incorrect response the test will be discontinued and the Test-Generator releases the alarm System Fault 1 and 2.

Single or multiple Trip-Lines may also be tested by three external test-signals.

6.2.4. Cross-check between CPUs of Test-Generator

The Test-Generator incorporates two redundant CPUs. Both CPUs must perform identically to release a test sequence. In case of failure of one CPU no test is released, but alarm System Fault 1 or 2 is released.

6.2.5. Selftest of CPUs

Selftest is performed after each Monitor test sequence.

The Selftest of both CPU routine includes:

- CPU RAM-Test
- CPU EEPROM-Test
- CPU Command-Test
- CPU Register-Test

If the Selftest detects a malfunction, alarm System Fault 1 or 2 is released.

7. Programming of the Modules

7.1. Programming of the Modules via Front Keyboard

Principle: Select a parameter via its ,name' **Pgg.ss**,
 in that **gg** : Parameter-group number and
ss : Step-number within the group,
 then display the value and alter if required.

Procedure:

Initiate programming phase by pressing keys **P** and **E** together; instead of the normal display P00.00. appears
 Select the group or step number with keys **Δ**, **∇**.
 Switch between Groups and Step Fields with the **◀** key
 Current value of the Parameters is displayed with key **E**.
 Select active position with the **◀** key
 Adjust the number in the active field with keys **Δ**, **∇**.
 Acknowledge and set with key **E**, Discard (original value remains) with key **P**.
 Return to operational mode with the **P** key. The display then returns to the current 'is' speed (with E1665) resp.
 to the current test-speed (with E1697)

See example below: Change parameter P01.01 from 2386 to 2387 or 2385.

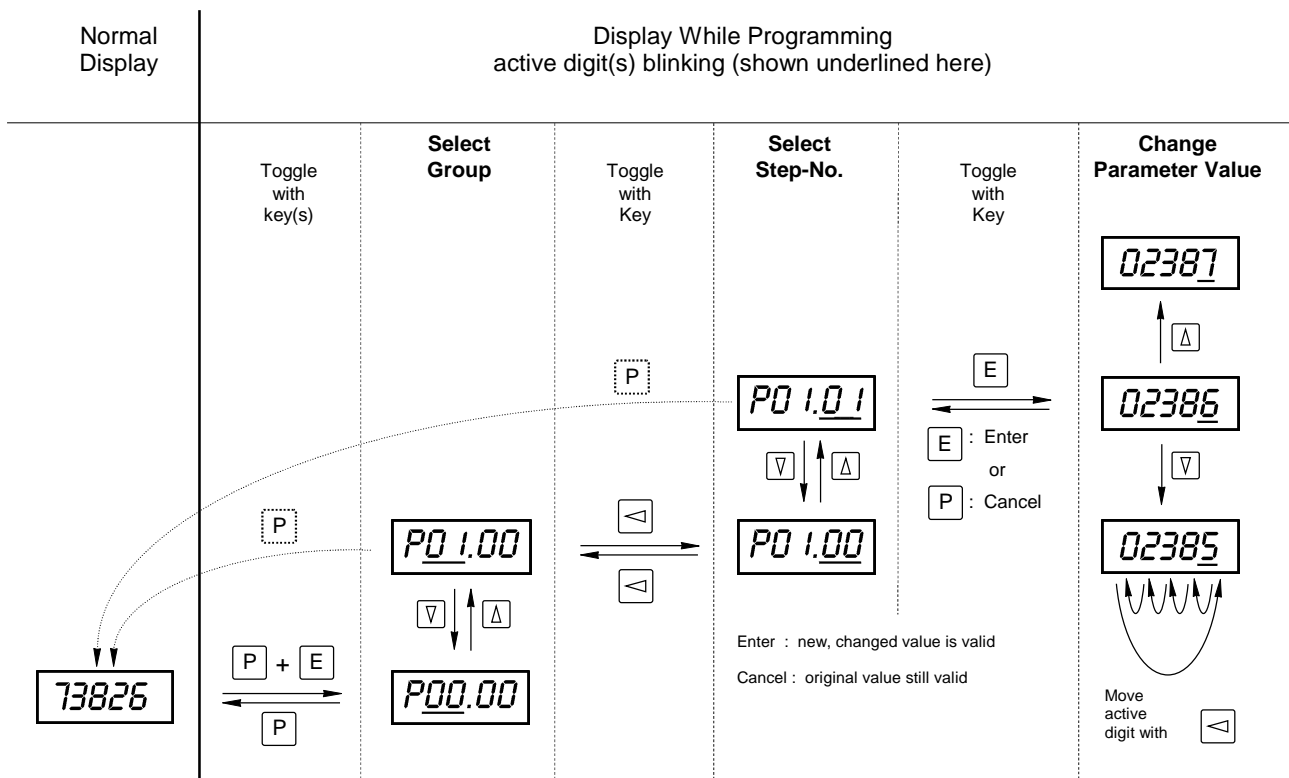

7.2. Reserved

7.3. Programming of the Modules via RS232-Interface

Only possible for OEM with special interface-software and either

1. adapter cable L3D05 by BRAUN

or

2. customized cable with connections PC (female connector) to E16 (male connector):

PC pin 2 to E16 pin 2

3 to 7

5 to 5

(of 9 pole Sub-D connectors)

Note:

The RS232-Interface serves only for parameter programming purposes, not for transmission of current data. States, alarms and measurement data are transmitted via PROFIBUS-Interface only.

7.4. Default Values

If not specified otherwise, the unit is supplied with default values as listed in the summary of parameters. In process of installation, the setting of its parameters inevitably must be adapted to the correct values according its application.

7.5. Behaviour in case of values exceeding limits

If the limits are exceeded the Display is blinking. The value will not be accepted.

7.6. Display of parameter values if access is locked

If access is locked the parameter values are displayed but cannot be changed. The values are shown blinking.

8. Parameters of Monitor E1665



8.1. Summary of parameters and their default values

Param. No.	Default Value	Parameter Function
P00.xx		Code figure, Parameter Lock
P00.00	0000	Code figure
.01	0000	New code figure
.02	0	Parameter Lock : 0: locked / 1: enabled
.03	0	Front side Reset: 0: not possible / 1: possible
P01.xx		Input, Scaling
P01.00	0	Reserved for future applications
.01	10000	Value of nominal input frequency in Hz
.02	0	Decimals of speed value for SP2, SP3 PROFIBUS-Output
.03	10000	Nominal speed in RPM
.04	00001	Lower limit of the speed range
.05	001	Predivider : 001 ... 255
.06	0	Reserved for future applications
.07	0	Decimals for acceleration
.08	01000	Maximum acceleration in XXXX or XXX.X RPM/sec
.09	1	No. of acceleration measurements included in calculation of SP1var
P02.xx		Display, Starter, Tests
P02.00	0	Watchdog 0 ... 3 (see table)
.01	0.3	Display updating sequence (in x.x sec)
.02	000	Starter time period (in xxx sec)
.03	1	Fix value = 1, do not change
.04	4	Sensor monitoring: 0 ... 4 (see table)
.05	1	Mode of Sensor Monitoring: 0 ... 7 (see table)
.06	1	Lowspeed Monitoring "n < SP2": 0 ... 4 (see table)
.07	5	Mode of Speed Comparison Test : 0 ... 5 (see table)
.08	030	Permissible Speed Difference between Sensors (in xxx RPM)
.09	05	Number of events before reporting
.10	1	Monitor Warning Alarm at Trip: 0 ... 4 (see table)
.11	1	Latch Monitor Warning Alarm: 0: no / 1: yes, all alarms / 2: yes, first one only
P03.xx		Overspeed Alarm SP1
P03.00	00010	Setpoint SP1A in RPM
.01	05.0	Hysteresis bandwidth (XX.X % of SP1A)
.02	0	Alarm to be latched / energized or de-energized to trip: 0 ... 3 (see table)
.03	00001	Setpoint SP1B in RPM
.04	0	Setpoint SP1var : 0: not active / 1: active
		Continued on next page

Param. No.	Default Value	Parameter Function
P04.xx		Low Speed Alarm SP2
P04.00	00015	Setpoint SP2 in RPM
.01	05.0	Hysteresis bandwidth (XX.X % of SP2)
.02	0	Fix value = 0, do not change
P05.xx		Alarm SP3
P05.00	00003	Setpoint SP3 in RPM
.01	05.0	Hysteresis bandwidth (XX.X % of SP3)
.02	1	Hysteresis position: 0: above / 1: below
.03	1	Relay state at "n > SP3" : 0 ... 3 (see table)
.04	0	Alarm state at sensor fault: 0: acc. to speed / 1: "n < SP" / 2: "n > SP"
.05	1	Setting of LEDs to status "n > SP3" : 0: LED3 on / 1: LED4 on
P06.xx		Eddy sensor
P06.00	00100	Reserved for future application
.01	00.0	Eddy sensor input check: input voltage upper limit in xx.x volts
.01	00.0	input voltage lower limit in xx.x volts
.03	00.0	current drain upper limit in xxx ma
.04	00.0	current drain lower limit in xxx ma
.05	0.0	Eddy sensor input hysteresis in x.x volts
P07.xx		Trip-Lines, Forward / Reverse Detection
P07.00	0	Trip-Line Monitoring: 0 ... 3 (see table)
.01	0	Signal level Trip-Feedback: 0: low = Trip / 1: high = Trip
.02	1	Forward / Reverse Detection Input level: 0: low = forward / 1: high = forward
.03	1	Forward / Reverse relay state: 0: de-energized = forward / 1: energized = forward
.04	0	Reserved for future application
P08.xx		Analog Output
P08.00	10000	High end speed value
.01	00000	Low end speed value
.02	1	Zero level: 0: dead zero / 1: live zero
.03	0	Output level at sensor fault: 0: no change / 1: min / 2: max
.04	0	Output direction: 0: 0/4 ... 20 ma / 1: 20 ... 4/0 ma
.05	1	Output response to test-speed: 0: test-speed / 1: frozen
.06	0	Test of Analog Output value: 0: no / 1: yes
P09.xx		Reserved for future application
P09.00	0	Reserved for future application
P10.xx		Voter No. 1 and LO1
P10.00	0	Operation Mode: 0 ... 5 (see table)
.01	0	Input Truth Level: 0: high = Trip / 1: low = Trip
.02	0	Voting logic: 0: 1oo2 / 1: 2oo2 / 2: 2oo3 / 3: 3oo3
.03	0	Truth Time until Trip: 0 ... 9 (see table)
.04	0	Trip latched: 0: no / 1: yes
.05	0	Delay of Antivalence Alarm: 0 ... 9 (see table)
.06	00110	Value for setpoint SPV1
		Continued on next page

Param. No.	Default Value	Parameter Function
P11.xx		Voter 2 and LO2
P11.00	0	Operation Mode: 0 ... 5 (see table)
.01	0	Input Truth Level: 0: high = Trip / 1: low = Trip
.02	0	Voting logic: 0: 1oo2 / 1: 2oo2 / 2: 2oo3 / 3: 3oo3
.03	0	Truth Time until Trip: 0 ... 9 (see table)
.04	0	Trip latched: 0: no / 1: yes
.05	0	Delay of Antivalence Alarm: 0 ... 11 (see table)
.06	00120	Value for setpoint SPV2
P12.xx		Voter 3 and LO3
P12.00	0	Operation Mode: 0 ... 5 (see table)
.01	0	Input Truth Level: 0: high = Trip / 1: low = Trip
.02	0	Voting logic: 0: 1oo2 / 1: 2oo2 / 2: 2oo3 / 3: 3oo3
.03	0	Truth Time until Trip: 0 ... 9 (see table)
.04	0	Trip latched: 0: no / 1: yes
.05	0	Delay of Antivalence Alarm: 0 ... 11 (see table)
.06	00130	Value for setpoint SPV3
P13.xx		Voter 4 and LO4
P13.00	0	Operation Mode: 0 ... 5 (see table)
.01	0	Input Truth Level: 0: high = Trip / 1: low = Trip
.02	0	Voting logic: 0: 1oo2 / 1: 2oo2 / 2: 2oo3 / 3: 3oo3
.03	0	Truth Time until Trip: 0 ... 9 (see table)
.04	0	Trip latched: 0: no / 1: yes
.05	0	Delay of Antivalence Alarm: 0 ... 11 (see table)
.06	00140	Value for setpoint SPV4
P14.xx		Voter 5 and LO5
P14.00	0	Operation Mode: 0 ... 5 (see table)
.01	0	Input Truth Level: 0: high = Trip / 1: low = Trip
.02	0	Voting logic: 0: 1oo2 / 1: 2oo2 / 2: 2oo3 / 3: 3oo3
.03	0	Truth Time until Trip: 0 ... 9 (see table)
.04	0	Trip latched: 0: no / 1: yes
.05	0	Delay of Antivalence Alarm: 0 ... 11 (see table)
.06	00150	Value for setpoint SPV5
P15.xx		Voter 6 and LO6
P15.00	0	Operation Mode: 0 ... 5 (see table)
.01	0	Input Truth Level: 0: high = Trip / 1: low = Trip
.02	0	Voting logic: 0: 1oo2 / 1: 2oo2 / 2: 2oo3 / 3: 3oo3
.03	0	Truth Time until Trip: 0 ... 9 (see table)
.04	0	Trip latched: 0: no / 1: yes
.05	0	Delay of Antivalence Alarm: 0 ... 11 (see table)
.06	00160	Value for setpoint SPV6
		Continued on next page

Param. No.	Default Value	Parameter Function
P16.xx		Reserved for future application
P16.00	0	Reserved for future application
.01	0	Reserved for future application
.02	0	Reserved for future application
.03	0	Reserved for future application
.04	0	Reserved for future application
.05	0	Reserved for future application
.06	00000	Reserved for future application
P17.xx		Data Interface
P17.00	016	PROFIBUS-Interface Device no.

Parameter Group P00.xx of Monitor E1665 Code Figure, Parameter Lock, Frontside Reset of Alarms	
Parameter No. Meaning of Parameter Setting Range of Parameter	Description of Parameters and their Settings
P00.00 Code Figure Range: 0000 .. 9999	If the parameters are locked (see P00.02), the code figure must be entered prior to any change of other parameters. If the code figure is not correct, -E 1- is displayed. Without code figure and P00.02 : 0 the values of all parameters may be inspected, but not changed.
P00.01 New Code Figure Range: 0000 .. 9999	A new code figure may be set in P00.01. Then it replaces the previous one.
P00.02 Parameter Lock Range: 0 .. 1	Setting 0 : Parameters are locked, change only possible with code figure 1 : Parameters unlocked, change of parameter values possible
P00.03 Frontside Reset of Alarms Range: 0 .. 1	Setting 0 : Frontside reset of alarms not possible 1 : Frontside reset of alarms possible with keys  and  .

Parameter Group P01.xx of Monitor E1665 Input Scaling and Measurement Configuration	
Parameter No. Meaning of Parameter Setting Range of Parameter	Description of Parameters and their Settings
P01.00 Reserved for future applications	
	<p>Description of Scaling: Scaling defines the relationship between the input signal frequency (in terms of Hz), and the corresponding display (in terms of RPM). Of course, they must refer to the same operation level. This reference point is recommended close to the high end of the intended operation range. In later operation, however, it may be overrun without event.</p> <p>Example: 1500 Hz corresponds to 3000 RPM : <div style="margin-left: 150px;">⇒ Step P01.01 : setting 01500 Step P01.03 : setting 03000</div></p>
P01.01 Nominal Input Frequency [Hz] Range: 00001 .. 99999	See description of Scaling.
P01.02 Decimals for P01.04, P04.00, P05.00 and for PROFIBUS Speed Data Output Range: 0 .. 1	Setting 0 : Setting range for P01.04, P04.00, P05.00 : 00001 to 99999 RPM 1 : Setting range for P01.04, P04.00, P05.00 : 0000.1 to 9999.9 RPM
P01.03 Nominal speed [RPM] Range: 00001 .. 99999	See description of Scaling.
P01.04 Lower Limit of the Speed Range Range as defined in P01.02	If the monitored speed falls below the value entered here the measured value is given as 0 both for the display and the alarms. The lower limit of the speed range is entered in units of RPM.

Parameter Group P01.xx (continued) of Monitor E1665 Measurement Configuration	
Parameter No. Meaning of Parameter Setting Range of Parameter	Description of Parameters and their Settings
P01.05 Predivider Range: 001 .. 255	The predivider is used only if the variable setpoint SP1var is active (P03.04 = 1). The predivider must then be set to the number of teeth of the gear wheel. The acceleration measurement is extended over one full rotation of the machine. Note: The predivider applies only to the primary measurement input. The two other measurement channels are not affected by the predivider.
P01.06 Reserved for future application	
P01.07 Decimals for acceleration Range: 0 .. 1	Setting 0 : setting of acceleration in XXXX RPM/sec 1 : setting of acceleration in XXX.X RPM/sec
P01.08 Maximum acceleration of the machine [RPM/sec] Range: 00001 .. 99999 resp. 0000.1 .. 9999.9	Setting is done in RPM/sec. Value must be set to the maximum possible acceleration (dN/dt max) of the machine in the worst case scenario. See also description of step P03.04.
P01.09 No of acceleration measurements included in calculation of SP1var Range: 1 .. 5	Recommended value is 1 or 2 measurements (equals to a measurement time of 20 or 40 milliseconds at a speed of 3000 RPM). More measurements included will improve the stability of the calculated setpoint SP1var, but also result in a delayed update rate.

Parameter Group P02.xx of Monitor E1665 Display, Starter time, Sensor Failure Monitoring	
Parameter No. Meaning of Parameter Setting Range of Parameter	Description of Parameters and their Settings
P02.00 Watchdog Range: 0 .. 3	If the Watchdog function is active, the Watchdog inputs must be toggled according to the settings below. If the inputs are not toggled within the time gap, Trip is released. Settings 0 : Watchdog not active 1 : Watchdog active, minimum 1 pulse within one second 2 : Watchdog active, minimum 1 pulse within two seconds 3 : Watchdog active, minimum 1 pulse within four seconds 4 or 5 or 6 or 7: not admissible with system E16x446
P02.01 Display updating sequence Range: 0.1 .. 9.9 [sec]	Recommended value is 0.3 sec . The rapid response of the alarms is not influenced by this procedure.
P02.02 Starter Time Period Range: 000 .. 999 [sec]	This step sets the starter time period (duration). The starter phase state for SP2 lasts from the beginning of the external starter signal plus the programmed time elapse following its end.
P02.03 Fix value = 1, do not change	
P02.04 Sensor Monitoring (Current and Signal Level) Range: 0 .. 4	A sensor fault will be reported according to the designated parameters and, if configured, latched until the reset is activated. Setting 0 : Monitoring disabled 1 : Not permissible 2 : Fault reported + Trip release, latched till reset 3 : Not permissible 4 : Fault reported without trip release (recommended setting)
P02.05 Mode of Sensor Monitoring Range: 0 .. 3	Setting 0 : Without monitoring (see Note 3) 1 : Checks sensor current drain 2 : Checks signal voltage level at stand still (see Note 1) 3 : Current drain and voltage level 4 : Inductive sensor (MPU) 5 : Reserved for future use 6 : Eddy sensor voltage level (see Note 2) 7 : Eddy sensor voltage level and current drain (see Note 2) Note 1: The voltage level check is only possible with Braun-sensor type A5S... . In this instance even at stand still a defective sensor or supply cable can be detected. Note 2: The signal voltage level (and current drain) is compared versus max/min-values as set in P06.01 to P06.04. Note 3: Selection of Setting 0 makes Step P02.04 meaningless.

Parameter Group P02.xx (continued) of Monitor E1665 Sensor Failure Monitoring	
Parameter No. Meaning of Parameter Setting Range of Parameter	Description of Parameters and their Settings
<p>P02.06 Lowspeed Monitoring "n < SP2" Range: 0 .. 4</p>	<p>Safety Note for systems E16x446.0xx (without analog output): For systems without analog output the Lowspeed Monitoring "n < SP2" is the only comprehensive protection versus a systematic fault of any type of speed sensor (no speed signal from sensor at running machine). Setting of P02.06 = 0 is allowed only for test purposes during commissioning of the machine. In normal operation P02.06 must be set to a value of 1 or 2 or 3 or 4.</p> <p>Function of Lowspeed Monitoring "n < SP2": Following the end of the Starter phase (Start-Up Bridging) the measured speed must exceed the value set for SP2. If the measured speed n is then lower than SP2, trip is released.</p> <p>Function of Starter Plausibility Check: If</p> <ul style="list-style-type: none"> • starter condition is true • and plausibility check is on • and speed exceeds 50% of overspeed setpoint SP1A <p>then Monitor Warning Alarm is released by plausibility check and event code E.3.0.1.0 is displayed.</p> <p>Setting E16x442.0xx :</p> <ul style="list-style-type: none"> 0 : Monitoring switched off (not permissible for systems E16x442.0xx, see safety note above) 1 : Trip and Alarm till rectified, starter plausibility check on 2 : Trip and Alarm latched, starter plausibility check on 3 : Trip and Alarm, till rectified / starter plausibility check off 4 : Trip and Alarm latched / starter plausibility check off <p>Safety Note for systems E16x446.1xx respective E16x446.2xx (with analog output): For these systems the Lowspeed Monitoring "n < SP2" may be switched off (setting P02.06 = 0) under the following conditions:</p> <ol style="list-style-type: none"> 1. P02.07 must be set to 0. 2. The analog output of each Monitor E1665 must be monitored by a PLC or a DCS for its plausibility, i.e. during run of the machine the outputs must signalize speed. 3. If the analog output of a Monitor E1665 does not signalize speed, the Monitor must be set to Trip condition by actuating the signal inputs of Voter 1.

Parameter Group P02.xx (continued) of Monitor E1665 Sensor Failure Monitoring	
Parameter No. Meaning of Parameter Setting Range of Parameter	Description of Parameters and their Settings
<p>P02.07 Speed Comparison Evaluation Mode Range: 0 .. 5</p>	<p>Speed comparison of the 3 sensors (only for systems E16x446.xx1) enables:</p> <ul style="list-style-type: none"> • Detection of incorrect installation of the sensor (distance from the tooth wheel too large or wrong position) even during the start-up bridging phase. • Detection of a fading function of a sensor during normal operation. <p>Each Monitor with speed signal inputs for A5S sensors has three measuring channels and receives the signals of all three sensors.</p> <p>Setting for systems</p> <p>0 : only the primary sensor will be evaluated; no redundancy (mandatory setting for systems with MPU input, i.e. modules E1665.xx3)</p> <p>1 : Trip is released if primary sensor fault is detected</p> <p>2 : only event message is released if primary sensor fault is detected, but only speed value of primary sensor is used for further evaluation</p> <p>3 : not permissible</p> <p>4 : only event message is released if primary sensor fault is detected, but the mean value of the three speed values is used for further evaluation</p> <p>5 : same as setting 4, but a trip released due to deviation is latched</p> <p>Setting 1 or 2 or 4 or 5 :</p> <p>During machine operation each Monitor compares its sensor input with those of its two neighbors. If the measured speed value of its own (primary) sensor in comparison with its two neighbors produces a discrepancy exceeding the tolerance level set at P02.08, the monitor's primary sensor will be reported as faulty.</p> <p>However, should all three measured speed values deviate from each other for more than the specified tolerance, the monitor will release trip.</p> <p>Note:</p> <p>Setting P02.07 = 4 or 5 avoids a trip release caused by a sensor fault during the automatic test procedure and are recommended settings (only if P02.06 is not = 0).</p> <p>Example:</p> <p>Monitor A is tested for overspeed, at the same time the signal from sensor B drops out. Monitor B reports an event, but continues to evaluate the signals from sensors A and C.</p>

Parameter Group P02.xx (continued) of Monitor E1665 Sensor Failure Monitoring																															
Parameter No. Meaning of Parameter Setting Range of Parameter	Description of Parameters and their Settings																														
P02.08 Permissible Speed Difference between Sensors [RPM] Range: 001 .. 999	Value for the permissible difference in RPM between the speed measurement of the primary sensor and that of the other two sensors before a fault is detected. Note: Primary sensor is the sensor the monitor supplies with power.																														
P02.09 Number of tests until alarm Range: 01 .. 99	Number of consecutively failed speed comparison tests which may occur before an event message is issued. Note: At speeds lower than 50% of the nominal speed, the number of tests is automatically increased to avoid incorrect alarms during acceleration phase of the machine. Example for Setting of P02.07 = 4: P02.08 = 030 (permissible difference between measured values = 30 RPM) P02.09 = 5 (Number of consecutive events till event message issued) With the example above an event message will be issued when the speed value of the primary sensor deviates by 30 RPM from the two other measured sensors five measurements in succession. When all three measurements of one monitor between themselves differ by more than 30 RPM (measurement of sensor A = 6031 RPM, of sensor B = 6000 RPM, of sensor C = 5969 RPM), the monitor will release trip.																														
P02.10 Monitor Warning Alarm also at Trip Condition Range: 0 .. 4	Setting depends on how the alarm is used according the specific application for detection of SOE (sequence of events). <table border="1" data-bbox="582 1317 1329 1615"> <thead> <tr> <th>Setting</th> <th>Alarm at Overspeed-Trip</th> <th>Alarm at Voter-Trip</th> <th>Alarm at Trip due to Trip-Line-Monitoring</th> <th>Alarm at Lowspeed-Trip</th> </tr> </thead> <tbody> <tr> <td>0</td> <td>No</td> <td>No</td> <td>Yes</td> <td>Yes</td> </tr> <tr> <td>1</td> <td>Yes</td> <td>Yes</td> <td>Yes</td> <td>Yes</td> </tr> <tr> <td>2</td> <td>No</td> <td>No</td> <td>No</td> <td>Yes</td> </tr> <tr> <td>3</td> <td>Yes</td> <td>Yes</td> <td>No</td> <td>Yes</td> </tr> <tr> <td>4</td> <td>No</td> <td>No</td> <td>No</td> <td>No</td> </tr> </tbody> </table> Note: The Monitor Warning Alarm is always released in case of detected sensor fault.	Setting	Alarm at Overspeed-Trip	Alarm at Voter-Trip	Alarm at Trip due to Trip-Line-Monitoring	Alarm at Lowspeed-Trip	0	No	No	Yes	Yes	1	Yes	Yes	Yes	Yes	2	No	No	No	Yes	3	Yes	Yes	No	Yes	4	No	No	No	No
Setting	Alarm at Overspeed-Trip	Alarm at Voter-Trip	Alarm at Trip due to Trip-Line-Monitoring	Alarm at Lowspeed-Trip																											
0	No	No	Yes	Yes																											
1	Yes	Yes	Yes	Yes																											
2	No	No	No	Yes																											
3	Yes	Yes	No	Yes																											
4	No	No	No	No																											
P02.11 First Alarm only of Monitor Warning Alarm and Event Messages and Range: 0 .. 2	The Monitor Warning Alarm and the event message can be latched. Setting 0 : not latched 1 : yes, in this case all occurring events are shown in the display as event combinations 2 : yes, in this case only the first occurring event is displayed																														

Parameter Group P03.xx of Monitor E1665 Overspeed Alarm SP1	
Parameter No. Meaning of Parameter Setting Range of Parameter	Description of Parameters and their Settings
P03.00 Overspeed Setpoint SP1A Range: 00001 .. 99999	The numerical value for the setpoint is set in terms of RPM.
P03.01 Alarm Hysteresis Width Range: 00.1 .. 99.9	<p>The hysteresis is the margin between condition "excess" (>) and "no excess" (<), defined by its bandwidth.</p> <p>The width of hysteresis is set as a percentage of the switching point.</p> <p>The position of the hysteresis for SP1 is determined beneath the setpoint.</p> <p>Example: With 5% Hysteresis and a setpoint of 10000 RPM an overspeed alarm is issued once 10000 RPM is exceeded and ceases should the speed drop below 9500 RPM.</p> <p>Note: The hysteresis is always calculated for SP1A. If SP1B is used and the alarm is not latched, hysteresis must be chosen that</p> <ul style="list-style-type: none"> • it is big enough to include SP1B to avoid bouncing of the trip relays • it is small enough to that the return point is not lower than normal operating speed. <p>Example: SP1A=3240 RPM, SP1B=3090 RPM, normal operating speed=3000 RPM.</p> <p>Then hysteresis must be minimum $(3240-3090)/3240 = 4.7\%$ and maximum $(3240-3000)/3000 = 7.9\%$.</p>
P03.02 Latching of Overspeed Alarm/ Energize or de-energize to Trip Range: 0 .. 3	<p>The overspeed alarm can be latched until externally reset.</p> <p>The trip relays can be programmed to energize or to de-energize to trip (released by Overspeed or externally via Voter) condition.</p> <p>Setting</p> <ul style="list-style-type: none"> 0 : alarm not latched, trip relays de-energize to trip 1 : alarm latched, trip relays de-energize to trip 2 : alarm not latched, trip relays energize to trip 3 : alarm latched, trip relays energize to trip
P03.03 Overspeed Setpoint SP1B Range: 00001 .. 99999	The numerical value for the setpoint is set in terms of RPM. SP1B is always valid as long as the input „SP1B valid" is true.

Parameter Group P03.xx (continued) of Monitor E1665
Overspeed Alarm SP1

Parameter No. Meaning of Parameter Setting Range of Parameter	Description of Parameters and their Settings														
<p>P03.04 Overspeed Setpoint SP1var not active / active Range: 0 .. 1</p> <p>Attention: If P03.04 = 1: The value of SP1A (P03.00) must not be lower than the value of SP1B (P03.03), else SP1B will always be valid during acceleration phase.</p>	<p>Setting 0 : overspeed setpoint SP1var is not active 1 : overspeed setpoint SP1var is active</p> <p>If the overspeed setpoint SP1var is not active, then SP1A is valid (respective SP1B as long as the input "SP1B valid" is true). If the overspeed setpoint SP1var is active, it is calculated depending on the measured acceleration in between the limits of SP1A and SP1B. If acceleration $dN/dt = 0$, then $SP1var = SP1A$. If acceleration $dN/dt = dN/dt \text{ max}$, then $SP1var = SP1B$.</p> <p>Example for values of SP1var: $dN/dt \text{ max} = 300 \text{ RPM/sec}$ $SP1A = 3240 \text{ RPM}$ (at acceleration rate of 0 RPM/sec) $SP1B = 3090 \text{ RPM}$ (at acceleration rate of 300 RPM/sec)</p> <table border="1" data-bbox="598 969 1342 1294"> <thead> <tr> <th>measured acceleration</th> <th>calculated value SP1var</th> </tr> </thead> <tbody> <tr> <td>300 RPM/sec</td> <td>3090 RPM</td> </tr> <tr> <td>240 RPM/sec</td> <td>3120 RPM</td> </tr> <tr> <td>180 RPM/sec</td> <td>3150 RPM</td> </tr> <tr> <td>120 RPM/sec</td> <td>3180 RPM</td> </tr> <tr> <td>60 RPM/sec</td> <td>3210 RPM</td> </tr> <tr> <td>0 RPM/sec</td> <td>3240 RPM</td> </tr> </tbody> </table> <p>See also graph below</p>	measured acceleration	calculated value SP1var	300 RPM/sec	3090 RPM	240 RPM/sec	3120 RPM	180 RPM/sec	3150 RPM	120 RPM/sec	3180 RPM	60 RPM/sec	3210 RPM	0 RPM/sec	3240 RPM
measured acceleration	calculated value SP1var														
300 RPM/sec	3090 RPM														
240 RPM/sec	3120 RPM														
180 RPM/sec	3150 RPM														
120 RPM/sec	3180 RPM														
60 RPM/sec	3210 RPM														
0 RPM/sec	3240 RPM														

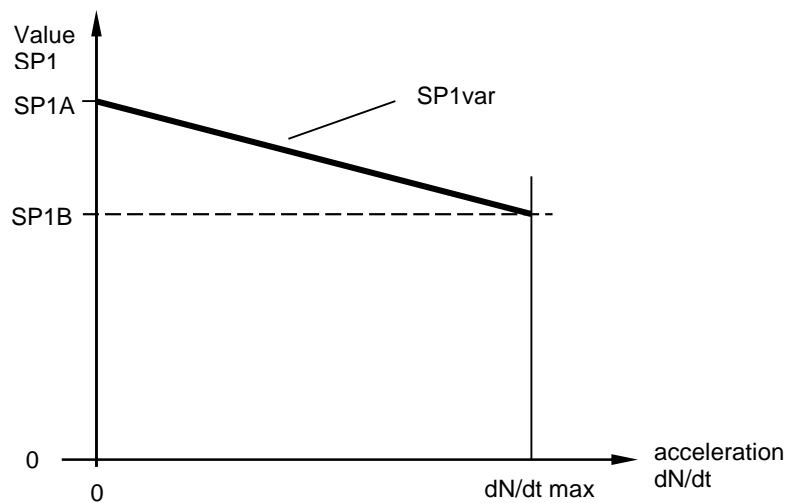

Figure 12:
 SP1 as a variable
 of the acceleration

Parameter Group P04.xx of Monitor E1665 Lowspeed Alarm SP2	
Parameter No. Meaning of Parameter Setting Range of Parameter	Description of Parameters and their Settings
P04.00 Lowspeed Setpoint SP2 Range: 00001 .. 99999	The numerical value for the setpoint is expressed as RPM.
P04.01 Alarm Hysteresis Width Range: 00.1 .. 99.9	The hysteresis is the margin between condition "excess" (>) and "no excess" (<), defined by its bandwidth. The width of hysteresis is set as a percentage of the switching point. The position of the hysteresis of SP2 is determined above the setpoint. Example: With 5% Hysteresis and a setpoint of 100 RPM a Lowspeed alarm is issued once speed drops below 100 RPM and ceases once speed exceeds 105 RPM.
P04.02 Fix value = 0, do not change	

Parameter Group P05.xx of Monitor E1665 Alarm SP3	
Parameter No. Meaning of Parameter Setting Range of Parameter	Description of Parameters and their Settings
P05.00 Setpoint SP3 Range: 00001 .. 99999	The numerical value for the setpoint is expressed as RPM.
P05.01 Alarm Hysteresis Width Range: 00.1 .. 99.9	The hysteresis is the margin between condition "excess" (>) and "no excess" (<), defined by its bandwidth. The width of hysteresis is set as a percentage of the switching point.
P05.02 Hysteresis position Range: 0 .. 1	The hysteresis band for SP3 may be placed above or below setpoint. Setting 0 : Hysteresis above SP3 1 : Hysteresis below SP3
P05.03 Relay State at n > SP3 Range: 0 ... 3	Setting 0 : Relay energized if n > SP3 1 : Relay de-energized if n > SP3 2 : Relay energized if n > SP3, output frozen at test 3 : Relay de-energized if n > SP3, output frozen at test
P05.04 Alarm State at Sensor Event Condition Range: 0 .. 2	If a sensor fault is detected, alarm SP3 can be forced into a defined state. Setting 0 : Alarm SP3 according to measured rotational speed 1 : Alarm SP3 forced to state n < SP3 2 : Alarm SP3 forced to state n > SP3
P05.05 Status of LEDs 3 and 4 for Alarm n > SP3 Range: 0 .. 1	Assignment LED (red or green) to alarm state n > SP3. Setting 0 : LED3 (green) on at n > SP3 1 : LED4 (red) on at n > SP3

Parameter Group P06.xx of Monitor E1665 Eddy sensor input and MPU input	
Parameter No. Meaning of Parameter Setting Range of Parameter	Description of Parameters and their Settings
P06.00 Reserved for future application	
	Eddy sensors must not be operated outside (manufacturer) specified limits of voltage level and supply current. These limits can be checked (see parameter P02.05).
P06.01 Input voltage upper limit Range: 00.0 to 99.9	Input check: input voltage upper limit in xx.x volts
P06.02 Input voltage lower limit Range: 00.0 to 99.9	input voltage lower limit in xx.x volts
P06.03 Current drain upper limit Range: 000 to 999	current drain upper limit in xxx ma
P06.04 Current drain lower limit Range: 000 to 999	current drain lower limit in xxx ma
P06.05 Signal input hysteresis Range: 0.0 to 2.5	Signal input hysteresis (sensitivity level) in x.x volts Note: with setting 0.0 hysteresis is approx 70 millivolts

Parameter Group P07.xx of Monitor E1665 Trip-Line-Monitoring, Rotational Direction Output	
Parameter No. Meaning of Parameter Setting Range of Parameter	Description of Parameters and their Settings
P07.00 Trip-Line-Monitoring Range: 0 .. 3	If activated the Monitor checks the output of the Trip-Lines. If two or three Trip-Lines indicate trip condition the monitor moves to trip status (Trip Lock Function). Following the reset signal the monitor releases the trip state for one second. Within this time the feedback signal must respond correctly, otherwise the monitor returns to trip status. Setting 0 : Trip-Line-Monitoring not active 1 : Trip-Line-Monitoring active, with response time until trip = 50 ms 2 : not admissible 3 : Trip-Line-Monitoring active, with response time until trip = 3 ms
P07.01 Trip-Line Level at Trip-Status Range: 0 .. 1	Setting 0 : Low Level at Trip-Status (relays de-energized to Trip) 1 : High-Level at Trip-Status (relays energized to Trip)
P07.02 Signal-Input Level for Rotational Direction Detection Range: 0 .. 1	Setting 0 : Signal level low is assigned to forward motion 1 : Signal level high is assigned to forward motion
P07.03 Relay State for status forward motion Range: 0 .. 1	Setting 0 : Relay de-energized at status forward motion 1 : Relay energized at status forward motion
P07.04 Reserved for future application.	

Parameter Group P08.xx of Monitor E1665 Analog Output	
Parameter No. Meaning of Parameter Setting Range of Parameter	Description of Parameters and their Settings
P08.00 High End of Analog Output Range: 00001 .. 99999	The high end defines the speed (in terms of RPM) at which the analog output delivers 20 ma (with P08.04 = 0), resp. 0 / 4 ma (with P08.04 = 1).
P08.01 Low End of Analog Output Range: 00000 .. 99999	The low end defines the speed (in terms of RPM) at which the analog output delivers 0 resp. 4 ma (with P08.04 = 0), resp. 20 ma (with P08.04 = 1).
P08.02 Analog Output Zero Level Range: 0 .. 1	Setting 0 : without live zero (0..20 ma) 1 : with live zero (4..20 ma)
P08.03 Output Level at Sensor Fault Range: 0 .. 1	Setting 0 : no change of output 1 : output goes to < 0 ma 2 : output goes to >20,8 ma
P08.04 Direction of Analog Output Range: 0 .. 1	Setting 0 : output is increasing with increasing speed (0/4 ...20 ma) 1 : output is decreasing with increasing speed (20....4/0 ma)
P08.05 Output Response at Test-speed Range: 0 .. 1	Setting 0 : output follows test-speed 1 : output is frozen (on last value before test starts) during test-speed
P08.06 Test of Analog Output Value Range: 0 .. 1	Analog output may be checked for short circuit or no load or its correct output, detected via integrated control feedback. Setting 0 : output value is not tested (mandatory with versions E1665.0xx respective E1665.1xx) 1 : value of output is tested (only possible with versions E1665.2xx)

Parameter Group P09.xx of Monitor E1665 Reserved for future application	
Parameter No. Meaning of Parameter Setting Range of Parameter	Description of Parameters and their Settings
P09.00 Reserved for future application	

Parameter Group P10.xx of Monitor E1665 Voter 1 and Logic Output LO1																																											
Parameter No. Meaning of Parameter Setting Range of Parameter	Description of Parameters and their Settings																																										
P10.00 Operation mode Range: 0 .. 5	Setting 0 : Voter inactive 1 : Voter always active (over entire speed range) 2 : Voter only active, if n > SPV1 3 : Voter only active, if n < SPV1 4 : Voter inactive, output LO1 low, if n > SPV1 5 : Voter inactive, output LO1 high, if n > SPV1																																										
P10.01 Input Truth Level Range: 0 .. 1	Setting 0 : high level at inputs is assigned to trip condition 1 : low level at inputs is assigned to trip condition																																										
P10.02 Voting Logic Range: 0 .. 3	Selectable Voting Logics are: <ul style="list-style-type: none"> • 1oo2 : trip is released if 1 of 2 inputs signalizes trip condition • 2oo2 : trip is released if 2 of 2 inputs signalize trip condition • 2oo3 : trip is released if 2 of 3 inputs signalize trip condition • 3oo3 : trip is released if 3 of 3 inputs signalize trip condition Setting 0 : 1oo2 (only inputs 1 and 2 of voter 1 are monitored) 1 : 2oo2 (only inputs 1 and 2 of voter 1 are monitored) 2 : 2oo3 (all three inputs of voter 1 are monitored) 3 : 3oo3 (all three inputs of voter 1 are monitored)																																										
P10.03 Truth Time until Trip Range: 0 .. 11	If the trip signal is shorter than the minimum truth time, the signal is not valid (anti bouncing filter). If the signal is longer than the maximum truth time, the signal is valid and trip is released. Note: Signal truth times in between min. and max. may release trip. Maximum response time until output of Trip-Lines go to trip status is maximum truth time + 3 milliseconds.	<table border="1"> <thead> <tr> <th rowspan="2">Setting</th> <th colspan="2">Trip after</th> </tr> <tr> <th>min.</th> <th>max.</th> </tr> </thead> <tbody> <tr><td>0</td><td>3 msec</td><td>5 msec</td></tr> <tr><td>1</td><td>6 msec</td><td>9 msec</td></tr> <tr><td>2</td><td>12 msec</td><td>16 msec</td></tr> <tr><td>3</td><td>24 msec</td><td>28 msec</td></tr> <tr><td>4</td><td>48 msec</td><td>52 msec</td></tr> <tr><td>5</td><td>96 msec</td><td>102 msec</td></tr> <tr><td>6</td><td>192 msec</td><td>202 msec</td></tr> <tr><td>7</td><td>384 msec</td><td>400 msec</td></tr> <tr><td>8</td><td>768 msec</td><td>800 msec</td></tr> <tr><td>9</td><td>1.570 sec</td><td>1.600 sec</td></tr> <tr><td>10</td><td>3.140 sec</td><td>3.200 sec</td></tr> <tr><td>11</td><td>6.280 sec</td><td>6.400 sec</td></tr> </tbody> </table>	Setting	Trip after		min.	max.	0	3 msec	5 msec	1	6 msec	9 msec	2	12 msec	16 msec	3	24 msec	28 msec	4	48 msec	52 msec	5	96 msec	102 msec	6	192 msec	202 msec	7	384 msec	400 msec	8	768 msec	800 msec	9	1.570 sec	1.600 sec	10	3.140 sec	3.200 sec	11	6.280 sec	6.400 sec
Setting	Trip after																																										
	min.	max.																																									
0	3 msec	5 msec																																									
1	6 msec	9 msec																																									
2	12 msec	16 msec																																									
3	24 msec	28 msec																																									
4	48 msec	52 msec																																									
5	96 msec	102 msec																																									
6	192 msec	202 msec																																									
7	384 msec	400 msec																																									
8	768 msec	800 msec																																									
9	1.570 sec	1.600 sec																																									
10	3.140 sec	3.200 sec																																									
11	6.280 sec	6.400 sec																																									
P10.04 Trip by Voter 1 latched Range: 0 .. 1	Setting 0 : trip by voter 1 is not latched 1 : trip by voter 1 is latched until reset																																										

<p>P10.05 Delay of Antivalence Alarm Range: 0 .. 9</p>	<p>To avoid unnecessary Antivalence Alarms due to shifted trip release signals at the voter inputs a delay may be introduced. Antivalence alarm will then be released only if the time shift between the signals exceeds the set delay.</p> <p>Setting</p> <ul style="list-style-type: none"> 0 : no delay 1 : delay = 100 milliseconds 2 : delay = 500 milliseconds 3 : delay = 1 second 4 : delay = 2 seconds 5 : delay = 3 seconds 6 : delay = 5 seconds 7 : delay = 15 seconds 8 : delay = 30 seconds 9 : delay = 60 seconds <p>Note: The input signals will be monitored for antivalence only, if the voter is active.</p>
<p>P10.06 Setpoint SPV1 Range: 00001 .. 99999 [RPM]</p>	<p>Depending on setting of P10.00, SPV1 controls the activity of voter 1 or controls directly the output LO1. SPV1 is set in terms of RPM.</p>

Parameter Group P11.xx of Monitor E1665 Voter 2 and Logic Output LO2																																											
Parameter No. Meaning of Parameter Setting Range of Parameter	Description of Parameters and their Settings																																										
P11.00 Operation mode Range: 0 .. 5	Setting 0 : Voter inactive 1 : Voter always active (over entire speed range) 2 : Voter only active, if n > SPV2 3 : Voter only active, if n < SPV2 4 : Voter inactive, output LO2 low, if n > SPV2 5 : Voter inactive, output LO2 high, if n > SPV2																																										
P11.01 Input Truth Level Range: 0 .. 1	Setting 0 : high level at inputs is assigned to trip condition 1 : low level at inputs is assigned to trip condition																																										
P11.02 Voting Logic Range: 0 .. 3	Selectable Voting Logics are: <ul style="list-style-type: none"> • 1oo2 : trip is released if 1 of 2 inputs signalizes trip condition • 2oo2 : trip is released if 2 of 2 inputs signalize trip condition • 2oo3 : trip is released if 2 of 3 inputs signalize trip condition • 3oo3 : trip is released if 3 of 3 inputs signalize trip condition Setting 0 : 1oo2 (only inputs 1 and 2 of voter 2 are monitored) 1 : 2oo2 (only inputs 1 and 2 of voter 2 are monitored) 2 : 2oo3 (all three inputs of voter 2 are monitored) 3 : 3oo3 (all three inputs of voter 2 are monitored)																																										
P11.03 Truth Time until Trip Range: 0 .. 11	If the trip signal is shorter than the minimum truth time, the signal is not valid (anti bouncing filter). If the signal is longer than the maximum truth time, the signal is valid and trip is released. Note: Signal truth times in between min. and max. may release trip. Maximum response time until output of Trip-Lines go to trip status is maximum truth time + 3 milliseconds.	<table border="1"> <thead> <tr> <th rowspan="2">Setting</th> <th colspan="2">Trip after</th> </tr> <tr> <th>min.</th> <th>max.</th> </tr> </thead> <tbody> <tr><td>0</td><td>3 msec</td><td>5 msec</td></tr> <tr><td>1</td><td>6 msec</td><td>9 msec</td></tr> <tr><td>2</td><td>12 msec</td><td>16 msec</td></tr> <tr><td>3</td><td>24 msec</td><td>28 msec</td></tr> <tr><td>4</td><td>48 msec</td><td>52 msec</td></tr> <tr><td>5</td><td>96 msec</td><td>102 msec</td></tr> <tr><td>6</td><td>192 msec</td><td>202 msec</td></tr> <tr><td>7</td><td>384 msec</td><td>400 msec</td></tr> <tr><td>8</td><td>768 msec</td><td>800 msec</td></tr> <tr><td>9</td><td>1.570 sec</td><td>1.600 sec</td></tr> <tr><td>10</td><td>3.140 sec</td><td>3.200 sec</td></tr> <tr><td>11</td><td>6.280 sec</td><td>6.400 sec</td></tr> </tbody> </table>	Setting	Trip after		min.	max.	0	3 msec	5 msec	1	6 msec	9 msec	2	12 msec	16 msec	3	24 msec	28 msec	4	48 msec	52 msec	5	96 msec	102 msec	6	192 msec	202 msec	7	384 msec	400 msec	8	768 msec	800 msec	9	1.570 sec	1.600 sec	10	3.140 sec	3.200 sec	11	6.280 sec	6.400 sec
Setting	Trip after																																										
	min.	max.																																									
0	3 msec	5 msec																																									
1	6 msec	9 msec																																									
2	12 msec	16 msec																																									
3	24 msec	28 msec																																									
4	48 msec	52 msec																																									
5	96 msec	102 msec																																									
6	192 msec	202 msec																																									
7	384 msec	400 msec																																									
8	768 msec	800 msec																																									
9	1.570 sec	1.600 sec																																									
10	3.140 sec	3.200 sec																																									
11	6.280 sec	6.400 sec																																									
P11.04 Trip by Voter 2 latched Range: 0 .. 1	Setting 0 : trip by voter 2 is not latched 1 : trip by voter 2 is latched until reset																																										

<p>P11.05 Delay of Antivalence Alarm Range: 0 .. 9</p>	<p>To avoid unnecessary Antivalence Alarms due to shifted trip release signals at the voter inputs a delay may be introduced. Antivalence alarm will then be released only if the time shift between the signals exceeds the set delay.</p> <p>Setting</p> <ul style="list-style-type: none"> 0 : no delay 1 : delay = 100 milliseconds 2 : delay = 500 milliseconds 3 : delay = 1 second 4 : delay = 2 seconds 5 : delay = 3 seconds 6 : delay = 5 seconds 7 : delay = 15 seconds 8 : delay = 30 seconds 9 : delay = 60 seconds <p>Note: The input signals will be monitored for antivalence only, if the voter is active.</p>
<p>P11.06 Setpoint SPV2 Range: 00001 .. 99999 [RPM]</p>	<p>Depending on setting of P11.00, SPV2 controls the activity of voter 2 or controls directly the output LO2. SPV2 is set in terms of RPM.</p>

Parameter Group P12.xx of Monitor E1665 Voter 3 and Logic Output LO3																																											
Parameter No. Meaning of Parameter Setting Range of Parameter	Description of Parameters and their Settings																																										
P12.00 Operation mode Range: 0 .. 5	Setting 0 : Voter inactive 1 : Voter always active (over entire speed range) 2 : Voter only active, if n > SPV3 3 : Voter only active, if n < SPV3 4 : Voter inactive, output LO3 low, if n > SPV3 5 : Voter inactive, output LO3 high, if n > SPV3																																										
P12.01 Input Truth Level Range: 0 .. 1	Setting 0 : high level at inputs is assigned to trip condition 1 : low level at inputs is assigned to trip condition																																										
P12.02 Voting Logic Range: 0 .. 3	Selectable Voting Logics are: <ul style="list-style-type: none"> • 1oo2 : trip is released if 1 of 2 inputs signalizes trip condition • 2oo2 : trip is released if 2 of 2 inputs signalize trip condition • 2oo3 : trip is released if 2 of 3 inputs signalize trip condition • 3oo3 : trip is released if 3 of 3 inputs signalize trip condition Setting 0 : 1oo2 (only inputs 1 and 2 of voter 3 are monitored) 1 : 2oo2 (only inputs 1 and 2 of voter 3 are monitored) 2 : 2oo3 (all three inputs of voter 3 are monitored) 3 : 3oo3 (all three inputs of voter 3 are monitored)																																										
P12.03 Truth Time until Trip Range: 0 .. 11	<p>If the trip signal is shorter than the minimum truth time, the signal is not valid (anti bouncing filter). If the signal is longer than the maximum truth time, the signal is valid and trip is released.</p> <p>Note: Signal truth times in between min. and max. may release trip. Maximum response time until output of Trip-Lines go to trip status is maximum truth time + 3 milliseconds.</p>	<table border="1"> <thead> <tr> <th rowspan="2">Setting</th> <th colspan="2">Trip after</th> </tr> <tr> <th>min.</th> <th>max.</th> </tr> </thead> <tbody> <tr><td>0</td><td>3 msec</td><td>5 msec</td></tr> <tr><td>1</td><td>6 msec</td><td>9 msec</td></tr> <tr><td>2</td><td>12 msec</td><td>16 msec</td></tr> <tr><td>3</td><td>24 msec</td><td>28 msec</td></tr> <tr><td>4</td><td>48 msec</td><td>52 msec</td></tr> <tr><td>5</td><td>96 msec</td><td>102 msec</td></tr> <tr><td>6</td><td>192 msec</td><td>202 msec</td></tr> <tr><td>7</td><td>384 msec</td><td>400 msec</td></tr> <tr><td>8</td><td>768 msec</td><td>800 msec</td></tr> <tr><td>9</td><td>1.570 sec</td><td>1.600 sec</td></tr> <tr><td>10</td><td>3.140 sec</td><td>3.200 sec</td></tr> <tr><td>11</td><td>6.280 sec</td><td>6.400 sec</td></tr> </tbody> </table>	Setting	Trip after		min.	max.	0	3 msec	5 msec	1	6 msec	9 msec	2	12 msec	16 msec	3	24 msec	28 msec	4	48 msec	52 msec	5	96 msec	102 msec	6	192 msec	202 msec	7	384 msec	400 msec	8	768 msec	800 msec	9	1.570 sec	1.600 sec	10	3.140 sec	3.200 sec	11	6.280 sec	6.400 sec
Setting	Trip after																																										
	min.	max.																																									
0	3 msec	5 msec																																									
1	6 msec	9 msec																																									
2	12 msec	16 msec																																									
3	24 msec	28 msec																																									
4	48 msec	52 msec																																									
5	96 msec	102 msec																																									
6	192 msec	202 msec																																									
7	384 msec	400 msec																																									
8	768 msec	800 msec																																									
9	1.570 sec	1.600 sec																																									
10	3.140 sec	3.200 sec																																									
11	6.280 sec	6.400 sec																																									
P12.04 Trip by Voter3 latched Range: 0 .. 1	Setting 0 : trip by voter 3 is not latched 1 : trip by voter 3 is latched until reset																																										

<p>P12.05 Delay of Antivalence Alarm Range: 0 .. 9</p>	<p>To avoid unnecessary Antivalence Alarms due to shifted trip release signals at the voter inputs a delay may be introduced. Antivalence alarm will then be released only if the time shift between the signals exceeds the set delay.</p> <p>Setting</p> <ul style="list-style-type: none"> 0 : no delay 1 : delay = 100 milliseconds 2 : delay = 500 milliseconds 3 : delay = 1 second 4 : delay = 2 seconds 5 : delay = 3 seconds 6 : delay = 5 seconds 7 : delay = 15 seconds 8 : delay = 30 seconds 9 : delay = 60 seconds <p>Note: The input signals will be monitored for antivalence only, if the voter is active.</p>
<p>P12.06 Setpoint SPV3 Range: 00001 .. 99999 [RPM]</p>	<p>Depending on setting of P12.00, SPV3 controls the activity of voter 3 or controls directly the output LO3. SPV3 is set in terms of RPM.</p>

Parameter Group P13.xx of Monitor E1665 Voter 4 and Logic Output LO4																																											
Parameter No. Meaning of Parameter Setting Range of Parameter	Description of Parameters and their Settings																																										
P13.00 Operation mode Range: 0 .. 5	Setting 0 : Voter inactive 1 : Voter always active (over entire speed range) 2 : Voter only active, if n > SPV4 3 : Voter only active, if n < SPV4 4 : Voter inactive, output LO4 low, if n > SPV4 5 : Voter inactive, output LO4 high, if n > SPV4																																										
P13.01 Input Truth Level Range: 0 .. 1	Setting 0 : high level at inputs is assigned to trip condition 1 : low level at inputs is assigned to trip condition																																										
P13.02 Voting Logic Range: 0 .. 3	Selectable Voting Logics are: <ul style="list-style-type: none"> • 1oo2 : trip is released if 1 of 2 inputs signalizes trip condition • 2oo2 : trip is released if 2 of 2 inputs signalize trip condition • 2oo3 : trip is released if 2 of 3 inputs signalize trip condition • 3oo3 : trip is released if 3 of 3 inputs signalize trip condition Setting 0 : 1oo2 (only inputs 1 and 2 of voter 4 are monitored) 1 : 2oo2 (only inputs 1 and 2 of voter 4 are monitored) 2 : 2oo3 (all three inputs of voter 4 are monitored) 3 : 3oo3 (all three inputs of voter 4 are monitored)																																										
P13.03 Truth Time until Trip Range: 0 .. 11	<p>If the trip signal is shorter than the minimum truth time, the signal is not valid (anti bouncing filter). If the signal is longer than the maximum truth time, the signal is valid and trip is released.</p> <p>Note: Signal truth times in between min. and max. may release trip. Maximum response time until output of Trip-Lines go to trip status is maximum truth time + 3 milliseconds.</p>	<table border="1"> <thead> <tr> <th rowspan="2">Setting</th> <th colspan="2">Trip after</th> </tr> <tr> <th>min.</th> <th>max.</th> </tr> </thead> <tbody> <tr><td>0</td><td>3 msec</td><td>5 msec</td></tr> <tr><td>1</td><td>6 msec</td><td>9 msec</td></tr> <tr><td>2</td><td>12 msec</td><td>16 msec</td></tr> <tr><td>3</td><td>24 msec</td><td>28 msec</td></tr> <tr><td>4</td><td>48 msec</td><td>52 msec</td></tr> <tr><td>5</td><td>96 msec</td><td>102 msec</td></tr> <tr><td>6</td><td>192 msec</td><td>202 msec</td></tr> <tr><td>7</td><td>384 msec</td><td>400 msec</td></tr> <tr><td>8</td><td>768 msec</td><td>800 msec</td></tr> <tr><td>9</td><td>1.570 sec</td><td>1.600 sec</td></tr> <tr><td>10</td><td>3.140 sec</td><td>3.200 sec</td></tr> <tr><td>11</td><td>6.280 sec</td><td>6.400 sec</td></tr> </tbody> </table>	Setting	Trip after		min.	max.	0	3 msec	5 msec	1	6 msec	9 msec	2	12 msec	16 msec	3	24 msec	28 msec	4	48 msec	52 msec	5	96 msec	102 msec	6	192 msec	202 msec	7	384 msec	400 msec	8	768 msec	800 msec	9	1.570 sec	1.600 sec	10	3.140 sec	3.200 sec	11	6.280 sec	6.400 sec
Setting	Trip after																																										
	min.	max.																																									
0	3 msec	5 msec																																									
1	6 msec	9 msec																																									
2	12 msec	16 msec																																									
3	24 msec	28 msec																																									
4	48 msec	52 msec																																									
5	96 msec	102 msec																																									
6	192 msec	202 msec																																									
7	384 msec	400 msec																																									
8	768 msec	800 msec																																									
9	1.570 sec	1.600 sec																																									
10	3.140 sec	3.200 sec																																									
11	6.280 sec	6.400 sec																																									
P13.04 Trip by Voter 4 latched Range: 0 .. 1	Setting 0 : trip by voter 4 is not latched 1 : trip by voter 4 is latched until reset																																										

<p>P13.05 Delay of Antivalence Alarm Range: 0 .. 9</p>	<p>To avoid unnecessary Antivalence Alarms due to shifted trip release signals at the voter inputs a delay may be introduced. Antivalence alarm will then be released only if the time shift between the signals exceeds the set delay.</p> <p>Setting</p> <ul style="list-style-type: none"> 0 : no delay 1 : delay = 100 milliseconds 2 : delay = 500 milliseconds 3 : delay = 1 second 4 : delay = 2 seconds 5 : delay = 3 seconds 6 : delay = 5 seconds 7 : delay = 15 seconds 8 : delay = 30 seconds 9 : delay = 60 seconds <p>Note: The input signals will be monitored for antivalence only, if the voter is active.</p>
<p>P13.06 Setpoint SPV4 Range: 00001 .. 99999 [RPM]</p>	<p>Depending on setting of P13.00, SPV4 controls the activity of voter 4 or controls directly the output LO4. SPV4 is set in terms of RPM.</p>

Parameter Group P14.xx of Monitor E1665 Voter 5 and Logic Output LO5																																											
Parameter No. Meaning of Parameter Setting Range of Parameter	Description of Parameters and their Settings																																										
P14.00 Operation mode Range: 0 .. 5	Setting 0 : Voter inactive 1 : Voter always active (over entire speed range) 2 : Voter only active, if n > SPV5 3 : Voter only active, if n < SPV5 4 : Voter inactive, output LO5 low, if n > SPV5 5 : Voter inactive, output LO5 high, if n > SPV5																																										
P14.01 Input Truth Level Range: 0 .. 1	Setting 0 : high level at inputs is assigned to trip condition 1 : low level at inputs is assigned to trip condition																																										
P14.02 Voting Logic Range: 0 .. 3	Selectable Voting Logics are: <ul style="list-style-type: none"> • 1oo2 : trip is released if 1 of 2 inputs signalizes trip condition • 2oo2 : trip is released if 2 of 2 inputs signalize trip condition • 2oo3 : trip is released if 2 of 3 inputs signalize trip condition • 3oo3 : trip is released if 3 of 3 inputs signalize trip condition Setting 0 : 1oo2 (only inputs 1 and 2 of voter 5 are monitored) 1 : 2oo2 (only inputs 1 and 2 of voter 5 are monitored) 2 : 2oo3 (all three inputs of voter 5 are monitored) 3 : 3oo3 (all three inputs of voter 5 are monitored)																																										
P14.03 Truth Time until Trip Range: 0 .. 11	<p>If the trip signal is shorter than the minimum truth time, the signal is not valid (anti bouncing filter). If the signal is longer than the maximum truth time, the signal is valid and trip is released.</p> <p>Note: Signal truth times in between min. and max. may release trip. Maximum response time until output of Trip-Lines go to trip status is maximum truth time + 3 milliseconds.</p>	<table border="1"> <thead> <tr> <th rowspan="2">Setting</th> <th colspan="2">Trip after</th> </tr> <tr> <th>min.</th> <th>max.</th> </tr> </thead> <tbody> <tr><td>0</td><td>3 msec</td><td>5 msec</td></tr> <tr><td>1</td><td>6 msec</td><td>9 msec</td></tr> <tr><td>2</td><td>12 msec</td><td>16 msec</td></tr> <tr><td>3</td><td>24 msec</td><td>28 msec</td></tr> <tr><td>4</td><td>48 msec</td><td>52 msec</td></tr> <tr><td>5</td><td>96 msec</td><td>102 msec</td></tr> <tr><td>6</td><td>192 msec</td><td>202 msec</td></tr> <tr><td>7</td><td>384 msec</td><td>400 msec</td></tr> <tr><td>8</td><td>768 msec</td><td>800 msec</td></tr> <tr><td>9</td><td>1.570 sec</td><td>1.600 sec</td></tr> <tr><td>10</td><td>3.140 sec</td><td>3.200 sec</td></tr> <tr><td>11</td><td>6.280 sec</td><td>6.400 sec</td></tr> </tbody> </table>	Setting	Trip after		min.	max.	0	3 msec	5 msec	1	6 msec	9 msec	2	12 msec	16 msec	3	24 msec	28 msec	4	48 msec	52 msec	5	96 msec	102 msec	6	192 msec	202 msec	7	384 msec	400 msec	8	768 msec	800 msec	9	1.570 sec	1.600 sec	10	3.140 sec	3.200 sec	11	6.280 sec	6.400 sec
Setting	Trip after																																										
	min.	max.																																									
0	3 msec	5 msec																																									
1	6 msec	9 msec																																									
2	12 msec	16 msec																																									
3	24 msec	28 msec																																									
4	48 msec	52 msec																																									
5	96 msec	102 msec																																									
6	192 msec	202 msec																																									
7	384 msec	400 msec																																									
8	768 msec	800 msec																																									
9	1.570 sec	1.600 sec																																									
10	3.140 sec	3.200 sec																																									
11	6.280 sec	6.400 sec																																									
P14.04 Trip by Voter 5 latched Range: 0 .. 1	Setting 0 : trip by voter 5 is not latched 1 : trip by voter 5 is latched until reset																																										

<p>P14.05 Delay of Antivalence Alarm Range: 0 .. 9</p>	<p>To avoid unnecessary Antivalence Alarms due to shifted trip release signals at the voter inputs a delay may be introduced. Antivalence alarm will then be released only if the time shift between the signals exceeds the set delay.</p> <p>Setting</p> <ul style="list-style-type: none"> 0 : no delay 1 : delay = 100 milliseconds 2 : delay = 500 milliseconds 3 : delay = 1 second 4 : delay = 2 seconds 5 : delay = 3 seconds 6 : delay = 5 seconds 7 : delay = 15 seconds 8 : delay = 30 seconds 9 : delay = 60 seconds <p>Note: The input signals will be monitored for antivalence only, if the voter is active.</p>
<p>P14.06 Setpoint SPV5 Range: 00001 .. 99999 [RPM]</p>	<p>Depending on setting of P14.00, SPV5 controls the activity of voter 5 or controls directly the output LO5. SPV5 is set in terms of RPM.</p>

Parameter Group P15.xx of Monitor E1665 Voter 6 and Logic Output LO6																																											
Parameter No. Meaning of Parameter Setting Range of Parameter	Description of Parameters and their Settings																																										
P15.00 Operation mode Range: 0 .. 5	Setting 0 : Voter inactive 1 : Voter always active (over entire speed range) 2 : Voter only active, if n > SPV6 3 : Voter only active, if n < SPV6 4 : Voter inactive, output LO6 low, if n > SPV6 5 : Voter inactive, output LO6 high, if n > SPV6																																										
P15.01 Input Truth Level Range: 0 .. 1	Setting 0 : high level at inputs is assigned to trip condition 1 : low level at inputs is assigned to trip condition																																										
P15.02 Voting Logic Range: 0 .. 3	Selectable Voting Logics are: <ul style="list-style-type: none"> • 1oo2 : trip is released if 1 of 2 inputs signalizes trip condition • 2oo2 : trip is released if 2 of 2 inputs signalize trip condition • 2oo3 : trip is released if 2 of 3 inputs signalize trip condition • 3oo3 : trip is released if 3 of 3 inputs signalize trip condition Setting 0 : 1oo2 (only inputs 1 and 2 of voter 6 are monitored) 1 : 2oo2 (only inputs 1 and 2 of voter 6 are monitored) 2 : 2oo3 (all three inputs of voter 6 are monitored) 3 : 3oo3 (all three inputs of voter 6 are monitored)																																										
P15.03 Truth Time until Trip Range: 0 .. 11	<p>If the trip signal is shorter than the minimum truth time, the signal is not valid (anti bouncing filter). If the signal is longer than the maximum truth time, the signal is valid and trip is released.</p> <p>Note: Signal truth times in between min. and max. may release trip. Maximum response time until output of Trip-Lines go to trip status is maximum truth time + 3 milliseconds.</p>	<table border="1"> <thead> <tr> <th rowspan="2">Setting</th> <th colspan="2">Trip after</th> </tr> <tr> <th>min.</th> <th>max.</th> </tr> </thead> <tbody> <tr><td>0</td><td>3 msec</td><td>5 msec</td></tr> <tr><td>1</td><td>6 msec</td><td>9 msec</td></tr> <tr><td>2</td><td>12 msec</td><td>16 msec</td></tr> <tr><td>3</td><td>24 msec</td><td>28 msec</td></tr> <tr><td>4</td><td>48 msec</td><td>52 msec</td></tr> <tr><td>5</td><td>96 msec</td><td>102 msec</td></tr> <tr><td>6</td><td>192 msec</td><td>202 msec</td></tr> <tr><td>7</td><td>384 msec</td><td>400 msec</td></tr> <tr><td>8</td><td>768 msec</td><td>800 msec</td></tr> <tr><td>9</td><td>1.570 sec</td><td>1.600 sec</td></tr> <tr><td>10</td><td>3.140 sec</td><td>3.200 sec</td></tr> <tr><td>11</td><td>6.280 sec</td><td>6.400 sec</td></tr> </tbody> </table>	Setting	Trip after		min.	max.	0	3 msec	5 msec	1	6 msec	9 msec	2	12 msec	16 msec	3	24 msec	28 msec	4	48 msec	52 msec	5	96 msec	102 msec	6	192 msec	202 msec	7	384 msec	400 msec	8	768 msec	800 msec	9	1.570 sec	1.600 sec	10	3.140 sec	3.200 sec	11	6.280 sec	6.400 sec
Setting	Trip after																																										
	min.	max.																																									
0	3 msec	5 msec																																									
1	6 msec	9 msec																																									
2	12 msec	16 msec																																									
3	24 msec	28 msec																																									
4	48 msec	52 msec																																									
5	96 msec	102 msec																																									
6	192 msec	202 msec																																									
7	384 msec	400 msec																																									
8	768 msec	800 msec																																									
9	1.570 sec	1.600 sec																																									
10	3.140 sec	3.200 sec																																									
11	6.280 sec	6.400 sec																																									
P15.04 Trip by Voter 6 latched Range: 0 .. 1	Setting 0 : trip by voter 6 is not latched 1 : trip by voter 6 is latched until reset																																										

<p>P15.05 Delay of Antivalence Alarm Range: 0 .. 9</p>	<p>To avoid unnecessary Antivalence Alarms due to shifted trip release signals at the voter inputs a delay may be introduced. Antivalence alarm will then be released only if the time shift between the signals exceeds the set delay.</p> <p>Setting</p> <ul style="list-style-type: none"> 0 : no delay 1 : delay = 100 milliseconds 2 : delay = 500 milliseconds 3 : delay = 1 second 4 : delay = 2 seconds 5 : delay = 3 seconds 6 : delay = 5 seconds 7 : delay = 15 seconds 8 : delay = 30 seconds 9 : delay = 60 seconds <p>Note: The input signals will be monitored for antivalence only, if the voter is active.</p>
<p>P15.06 Setpoint SPV6 Range: 00001 .. 99999 [RPM]</p>	<p>Depending on setting of P15.00, SPV6 controls the activity of voter 6 or controls directly the output LO6. SPV6 is set in terms of RPM.</p>

Parameter Group P16.xx of Monitor E1665 Reserved for future application	
Parameter No. Meaning of Parameter Setting Range of Parameter	Description of Parameters and their Settings
P16.00 Reserved for future application	
P16.01 Reserved for future application	
P16.02 Reserved for future application	
P16.03 Reserved for future application	
P16.04 Reserved for future application	
P16.05 Reserved for future application	
P16.06 Reserved for future application	

Parameter Group P17.xx of Monitor E1665 PROFIBUS	
Parameter No. Meaning of Parameter Setting Range of Parameter	Description of Parameters and their Settings
P17.00 Device No for PROFIBUS Range: 001 .. 125	All members of the PROFIBUS-Communication must have different device nos.

9. Parameters of Test-Generator E1697

9.1. Summary of parameters and their default values

Param. No.	Default Value	Parameter Function
P00.xx		Code figure, Parameter Lock
P00.00	0000	Code figure
.01	0000	New code figure
.02	0	Parameter Lock : 0: locked / 1: enabled
P01.xx		Output Scaling
P01.00	0	Reserved for future applications
.01	10000	Value of output frequency in Hz at nominal Test-Speed
.02	0	Reserved for future applications
.03	10000	Nominal Test-Speed in RPM
P02.xx		Monitor-Test Configuration
P02.00	1	Reserved for future applications
.01	0	Reserved for future applications
.02	1440	Test Interval in xxxx minutes
.03	0	De-energize / energize to Trip
.04	11000	Test-Speed 1: 'n > SP1'
.05	09000	Test-Speed 2: 'n < SP1'
P03.xx		Trip-Line Test Configuration
P03.00	01440	Test Interval in xxxxx minutes (max 65000)
.01	0	Test Mode: 0 ... 3 (see table)
.02	0	Reserved for future applications
.03	0	Feedback-Signal level at trip : 0: low / 1: high
.04	0	Reserved for future applications
.05	00	duration time for Trip-Line test in xx sec
.06	0	Reserved for future applications
.07	60	Waiting time after reset of alarms in xx sec
.08	0	Waiting time after test of a Trip-Line in xx sec
.09	0	Reserved for future applications
P04.xx		Data Interface
P04.00	020	PROFIBUS-Interface Device no.

9.2. Description of Parameters and their Settings of Test-Generator E1697

Parameter Group P00.xx of Test-Generator E1697 Code Figure, Parameter Lock	
Parameter No. Meaning of Parameter Setting Range of Parameter	Description of Parameters and their Settings
P00.00 Code Figure Range: 0000 .. 9999	If the parameters are locked (see P00.02), the code figure must be entered prior to any change of other parameters. If the code figure is not correct, -E 1- is displayed. Without code figure and P00.02 : 0 the values of all parameters may be inspected, but not changed.
P00.01 New Code Figure Range: 0000 .. 9999	A new code figure may be set in P00.01. Then it replaces the previous one.
P00.02 Parameter Lock Range: 0 .. 1	Setting 0 : Parameters are locked, change only possible with code figure 1 : Parameters unlocked, change of parameter values possible

Parameter Group P02.xx of Test-Generator E1697 Monitor Test	
Parameter No. Meaning of Parameter Setting Range of Parameter	Description of Parameters and their Settings
P02.00 Reserved for future applications	
P02.01 Reserved for future applications	
P02.02 Time Interval in between Monitor Test Sequences Range: 0001 .. 9999 [min]	The time interval in between the Monitor Test sequences can be set from 0001 to 9999 minutes. Recommended settings: any time in between 60 and 1440 minutes.
P02.03 De-energize/Energize to Trip resp. Test of SP1A and SP1B Range: 0 .. 3	<p>De-Energize/Energize depends on the setting of P03.02 of monitors E1665. Setting</p> <ul style="list-style-type: none"> 0 : if P03.02 of E1665 is set to 0 1 : not permissible 2 : if P03.02 of E1665 is set to 2 or 3 3 : if P03.02 of E1665 is set to 0 and test of SP1A and SP1B is required <p>Explanation: If P02.03 = 0 or 2, then Test-Speed 1 and 2: In the first step of the monitor auto test sequence, the monitor is tested with test-speed 1. Value for test-speed 1 must be > SP1 of monitor. In the second step of the monitor auto test sequence, the monitor is tested with test-speed 2. Value for test-speed 2 must be < SP1 of monitor.</p> <p>Example: SP1 of monitor is set to 3300 RPM. Recommended value for Test-speed 1 : 3305 RPM Recommended value for Test-speed 2 : 3295 RPM</p> <p>If P02.03 = 3, then P02.04 must be set to SP1A (P03.00 of E1665) and P02.05 must be set to SP1B (P03.03 of E1665). Test will then be performed with Test-Speed SP1A +/- 5RPM and with Test-Speed SP1B +/- 5RPM.</p>

Parameter Group P02.xx (continued) of Test-Generator E1697 Monitor Test	
Parameter No. Meaning of Parameter Setting Range of Parameter	Description of Parameters and their Settings
P02.04 Test-Speed 1 [RPM] resp. SP1A Range: 00001 .. 99999	See explanation of step P03.02
P02.05 Test-Speed 2 [RPM] resp. SP1B Range: 00001 .. 99999	See explanation of step P03.02

Parameter Group P03.xx of Test-Generator E1697 Trip-Line Test	
Parameter No. Meaning of Parameter Setting Range of Parameter	Description of Parameters and their Settings
P03.00 Time Interval in between Trip-Line Test Sequences Range: 00001 .. 65000 [min]	The time interval in between automatic (see P03.01) Trip-Line Test sequences can be set from 00001 to 65000 minutes. Recommended settings: as recommended by solenoid valve supplier, but not less than 60 minutes.
P03.01 Trip-Line Test Mode Range: 0 .. 3	Setting 0 : Trip-Line Test off, feedback signal from 2oo3 magnetic solenoid are not evaluated) 1 : Trip-Line Test sequence in automatic mode with interval set in P03.00; feedback signals from 2oo3 magnetic solenoid will be evaluated. In the feedback does signalize trip status, the output will hold the corresponding Trip-Line on trip status and the test is aborted. 2 : Trip-Line Test controlled by external signals, simultaneous test of 2 or 3 lines is inhibited, feedback signal from 2oo3 magnetic solenoid are not evaluated 3 : one single Trip-Line Test Sequence, externally triggered by signal Start Auto-Test-Sequence; feedback signals from 2oo3 magnetic solenoid will be evaluated, Note: If setting = 2 or = 4, all other parameters of group P03 are not relevant.
P03.02 Reserved for future application	
P03.03 Feedback Level from solenoid at trip state Range: 0 .. 1	Setting 0 : low level feedback expected at trip state 1 : high level feedback expected at trip state
P03.04 Reserved for future application	
P03.05 Duration of Trip-Line Test Range: 01 .. 99 [sec]	If automatic sequence is activated (P03.01 = 1 or = 3), each Trip-Line is set (subsequently) to trip condition for the duration set in P03.05. Duration is set in terms of seconds. Note: Setting 00 equals 01.
P03.06 Reserved for future application	
P03.07 Waiting Time after Reset of Alarms Range: 01 .. 99 [sec]	After a reset of an alarm, the Test-Generator waits for this time before it starts to check the external feedback signals. Waiting time is set in terms of seconds. Note: Setting 00 equals 01.

<p>P03.08 Waiting Time after test of a Trip-Line Range: 01 .. 99 [sec]</p>	<p>The Test-Generator waits after the test of a Trip-Line for this time before it permanently checks again the status of the feedback signals from the solenoid for No-Trip-state. Waiting time is set in terms of seconds.</p> <p>Note: Setting 00 equals 01.</p>
<p>P03.09 Reserved for future application</p>	

Parameter Group P04.xx of Test-Generator E1697 PROFIBUS	
Parameter No. Meaning of Parameter Setting Range of Parameter	Description of Parameters and their Settings
<p>P04.00 Device No for PROFIBUS Range: 001 .. 125</p>	<p>All members of the PROFIBUS-Communication must have different device nos.</p>

10. Event Codes and Troubleshooting

10.1. Event Codes on display of E1665

The Event Codes are shown in format E.0.x.x.x .

Depending on setting of P02.11 only the first occurred fault or all faults are displayed (combination of faults is possible).

Display	Explanation of Event Code
E.0.0.0.0	Overspeed trip (if P03.02 = 0)
E.0.x.x.1	Sensor failure (current or voltage), refer to P02.05
E.0.x.x.2	Deviation of primary sensor versus neighbor sensors, refer to P02.07
E.0.x.x.3	E.x.x.x.1 + E.x.x.x.2
E.0.x.x.4	Speed < SP2
E.0.x.x.5	E.x.x.x.1 + E.x.x.x.4
E.0.x.x.6	E.x.x.x.2 + E.x.x.x.4
E.0.x.x.7	E.x.x.x.1 + E.x.x.x.2 + E.x.x.x.4
E.0.x.1.x	Generator tests with zero speed
E.0.x.2.x	Trip by Voter
E.0.x.4.x	Internal relay fault
E.0.1.x.x	Failure detection during internal self test
E.0.2.x.x	Overspeed trip (if P03.02 = 1)
E.0.3.x.x	E.x.1.x.x + E.x.2.x.x
E.0.4.0.0 without Trip	Alarm caused by antivalence of Voter Signals or signals for Trip-Line-Monitoring (for troubleshooting refer to next page)
E.0.4.0.0 with Trip	Trip-Line Monitoring has caused trip
E.0.4.2.0	Trip by voter (with non-coincidence at inputs of voter)
E.0.6.x.x	E.x.2.x.x + E.x.4.x.x
E.0.8.0.0	Trip-Line Monitoring has caused trip
E.0.A.0.0	Trip due to Overspeed (and P07.00 = 1 or 3)
E.0.c.0.0	Trip-Line Monitoring has caused trip plus antivalence of signals for Trip-Line-Monitoring (for troubleshooting refer to next page)
E.3.0.1.0	Starter Input is active at speed > 50% of nominal speed, see also parameter P02.06
E.3.0.2.0	External Analog output event ('no load' or fault of connected device)
E.3.0.2.1	Internal Analog output event (fault on monitor board)
E.6.0.0.1	Parameter value changed via RS232-Interface
-E1-	Wrong code figure in step P00.00
-E4-	No test by E1697 for more than 7 days (releases also Monitor Warning Alarm)

10.2. Troubleshooting if display of Monitor reads E.0.4.x.x

Display E.0.4.x.x signalizes a fault (not all signals are identical) from the input signals for the voters or for Trip-Line-Monitoring (resp. feedbacks from 2oo3-solenoid).
The actual status of the signal inputs is shown in Special Display Mode 2.

Switching between Standard and Special Display Mode 2 by pressing keys Δ and \square simultaneously.

Special Display Mode 2

In Special Display Mode 2 LED1 and LED4 are blinking.

Steps of Special Display Mode 2 :

- 0._x.x.x
- 1._x.x.x
- 2._x.x.x
- 3._x.x.x
- 4._x.x.x

Steps of Special Display Mode 2 are selected with key Δ (next step) resp. key ∇ (previous step).

For troubleshooting only steps 3._x.x.x and 4._x.x.x are relevant.

The status of signal inputs for Trip-Line-Monitoring are shown in step 3.
Display of:

- 3._x.x.1 : Feedback signal from Trip-Line I is true
- 3._x.x.2 : Feedback signal from Trip-Line II is true
- 3._x.x.4 : Feedback signal from Trip-Line III is true

resp. all combinations hereof, for example:

- 3._x.x.7 : all Feedback signal from Trip-Lines are true

The voter signal inputs are shown in step 4._x.x.x

Display of:

- 4.n.0.0.1 : Voter n, input 1 active n = 1 - 6 (7 reserved)
- 4.n.0.0.2 : Voter n, input 2 active
- 4.n.0.0.4 : Voter n, input 3 active

resp. all combinations hereof, for example:

- 4.3.0.0.5 : Voter 3, inputs 1 und 3 active, input 2 not active.

While key \triangleleft is pressed, the input status latched at event will be shown, else the current input status.

Switch the input status of voter 1 to 6 with key \square .

10.3. Event codes on display of E1697

Display	Event
C0-E1	Trip status notification from Monitor A
C0-E2	Trip status notification from Monitor B
C0-E3	Trip status notification from Monitor A + B
C0-E4	Trip status notification from Monitor C
C0-E5	Trip status notification from Monitor A + C
C0-E6	Trip status notification from Monitor B + C
C0-E7	Trip status notification from Monitor A + B + C
C1-E1	Fault during Test of Monitor A at step 1
C1-E2	Fault during Test of Monitor A at step 2
C1-E3	Fault during Test of Monitor A at step 3
C2-E1	Fault during Test of Monitor B at step 1
C2-E2	Fault during Test of Monitor B at step 2
C2-E3	Fault during Test of Monitor B at step 3
C3-E1	Fault during Test of Monitor C at step 1
C3-E2	Fault during Test of Monitor C at step 2
C3-E3	Fault during Test of Monitor C at step 3
C7-E1	During Test of Monitor A or B or C at test speed 1 a regular trip has occurred
C7-E3	During Test of Monitor A or B or C with "forced trip" a regular trip has occurred
C9-E1	Fault of Monitor A subsequent to a test step
C9-E2	Fault of Monitor B subsequent to a test step
C9-E4	Fault of Monitor C subsequent to a test step
C9-E7	All Monitors on Trip at start of test
ECh0.1	Alarm notification from Monitor A
ECh0.2	Alarm notification from Monitor B
ECh0.3	Alarm notification from Monitor A + B
ECh0.4	Alarm notification from Monitor C
ECh0.5	Alarm notification from Monitor A + C
ECh0.6	Alarm notification from Monitor B + C
ECh0.7	Alarm notification from Monitor A + B + C
	Continued on next page

Event Codes on display of E1697 (continued)

Display	Explanation of Event Code (y = not relevant with this code)
E.0.y.y.1	Feedback signal I of 2oo3 valve block is in Trip-Status
E.0.y.y.2	Feedback signal II of 2oo3 valve block is in Trip-Status
E.0.y.y.4	Feedback signal III of 2oo3 valve block is in Trip-Status
E.0.y.y.7	Feedback signals I,II,III of 2oo3 valve block are in Trip-Status
E.1.y.y.0	Incorrect feedback signal I of 2oo3 valve block at test of Trip-Line I (no trip at test)
E.1.y.y.2	Incorrect feedback signal II of 2oo3 valve block at test of Trip-Line I (incorrect wiring)
E.1.y.y.4	Incorrect feedback signal III of 2oo3 valve block at test of Trip-Line I (incorrect wiring)
E.2.y.y.0	Incorrect feedback signal II of 2oo3 valve block at test of Trip-Line II (no trip at test)
E.2.y.y.4	Incorrect feedback signal III of 2oo3 valve block at test of Trip-Line II (incorrect wiring)
E.3.y.y.0	Incorrect feedback signal III of 2oo3 valve block at test of Trip-Line III (no trip at test)
FC-5.1	Test outputs are not synchronous: if alarm returns after reset, one of the test outputs has a hardware fault and E1697 must be replaced
FC-5.2	Input "Testlock" is active
FC-5.6	Input "Testlock" is active for more than 60 minutes

11. Revision notes

Date	Rev.	
23.03.2011	01	Editorial modification only : Chapter "Event-Codes" added
24.05.2011	01	Technical and editorial modification valid for E16x446-systems with serial nos exceeding 220849: E1697 with additional functionality of test SP1A and SP1B.
03.06.2011	01	Editorial modifications only: Adapter L3D02 for RS232-Interface amended. Event-Codes added.
09.08.2011	01	Editorial modification only: Parameters of group P06 changed to 'for future application'.
14.10.2011	01	Editorial modification only: E1697: Description of P02.03 updated.
06.12.2011	02	Editorial modification only: new document format
10.01.2012	03	Technical and editorial modifications valid for monitors E1665 exceeding serial 208965 resp. E16x446-systems with serial nos exceeding 220845: E1665 - sensor input voltage shown in special display mode 1 - additional setting for P02.10 = 4 Technical and editorial modification valid for E16x446-systems with serial nos exceeding 220845: Additional function: Trip-Circuits V and VI
21.05.2012	04	Technical and editorial modification valid for monitors E1665 exceeding serial 231199 resp. E16x446-systems with serial nos exceeding 220936: E1665 with additional setting for P02.06 = 3 or 4
12.10.2012	04	Editorial modification only: SIL2 certificate added in chapter 1.6.3.
12.11.2012	05	Editorial modifications only: Power supply of E1697 added in wiring diagram Technical and editorial modifications valid for monitors E1665 exceeding serial 233999 resp. E16x446-systems with serial nos exceeding 232905: E1665 - with analog output check and event detection - with optional Eddy Current Sensor input - sensor input voltage shown in special display mode 1 - additional setting for P02.10 = 4 - additional setting for P02.07 = 5 - additional settings for P05.03 = 3 or 4 - additional setting for P07.00 = 3 - meaning of parameters P10.05, P11.05, P12.05, P13.05, P14.05, P15.05 changed to: Delay of Antivalence Alarm - additional event codes E.3.0.x.0- additional event codes E.0.8.0.0 and E.0.c.0.0 - change of parameter values via RS232 sets monitor to trip status and display to event code E.6.0.0.1 - Profibus-Interface with additional datatype 8 for voter status
29.11.2012	05	Editorial modifications only: correction of misspellings
05.02.2013	05	Editorial modification only: Safety note for P02.06 added Expression "System Fault Alarm" replaced by "System Warning Alarm"
19.06.2014	05	Editorial modification only: Document changed to Bookmark Format
		To be continued on next page

15.09.2015	06	<p>Editorial modification only: Wording of Event Codes of Trip-Line-Test modified</p> <p>Technical and editorial modification valid for Monitors E1665 exceeding serial no 1506250030 resp. E16x446-systems with serial no exceeding 1506250059:</p> <ul style="list-style-type: none"> - Parameter CRC can be displayed, see chapter 5.1.5, Note: This modification requires Interface Software IS-RS232-E16 version 4.05 or higher - Tighter timing for "Truth Time until Trip" and additional settings 8 and 9 of voters 1 through 6, see steps P10.03 through P15.03 - If P03.02 is set to 2 or 3 (energize to trip), system will not trip at power up <p>Technical and editorial modification valid for Test-Generators E1697 exceeding serial no. 1506250033 resp. E16x446-systems with serial no exceeding 1506250059:</p> <ul style="list-style-type: none"> - Parameter CRC can be displayed, see chapter 6.1.5, Note: This modification requires Interface Software IS-RS232-E16 version 4.05 or higher
15.01.2016	07	<p>Technical and editorial modification: valid for E16x446-systems with serial no exceeding 1605150000: Watchdog Function added, see chapters 2.2.12 and 2.3.12 and step P02.00</p>
23.11.2021	08	<p>Editorial modification: Safety note in description of parameter P02.06 modified (distinguished for systems E16x446.0xx and E16x446.1xx/E16x446.2xx).</p>
05.12.2021	09	<p>Editorial modification: Parameter P02.07 limited to setting 0 for modules with speed input for MPU (E1665.xx3).</p>